



Leica TPS1200 User Manual

Version 5.5
English

- when it has to be **right**

Leica
Geosystems

Introduction

Purchase

Congratulations on the purchase of a TPS1200 series instrument.



This manual contains important safety directions as well as instructions for setting up the product and operating it. Refer to "6 Safety Directions" for further information. Read carefully through the User Manual before you switch on the product.

Product identification





The type and the serial number of your product are indicated on the type plate. Enter the type and serial number in your manual and always refer to this information when you need to contact your agency or Leica Geosystems authorized service workshop.

Type: _____

Serial No.: _____

Symbols

The symbols used in this manual have the following meanings:



Type	Description
 Danger	Indicates an imminently hazardous situation which, if not avoided, will result in death or serious injury.
 Warning	Indicates a potentially hazardous situation or an unintended use which, if not avoided, could result in death or serious injury.
 Caution	Indicates a potentially hazardous situation or an unintended use which, if not avoided, may result in minor or moderate injury and/or appreciable material, financial and environmental damage.
	Important paragraphs which must be adhered to in practice as they enable the product to be used in a technically correct and efficient manner.

Trademarks



- CompactFlash and CF are trademarks of SanDisk Corporation
 - Bluetooth is a registered trademark of Bluetooth SIG, Inc
- All other trademarks are the property of their respective owners.



Validity of this manual

	Description
General	This manual applies to all TPS1200 Series instruments. Where there are differences between the various models they are clearly described.
Telescope	In regard to the instrument EDM, a TPS1200 instrument may be equipped with one of two types of telescopes, which offer the same performance but differ in some technical details. The two different types can be distinguished by a rectangular (telescope type 1) or round (telescope type 2) shaped element, which is visible in the centre of the objective lens. Where there are technical differences between the two telescope types they are marked by the following pictograms, referring to the first or second type described above:

	Description
	<p>Telescope Type 1</p> <ul style="list-style-type: none"> • When measuring distances to a reflector with EDM mode "IR" this telescope type uses a wide infrared laser beam, which emerges coaxially from the telescope's objective. • Instruments that are equipped with a reflectorless EDM additionally offer the EDM modes "RL" and "LO". When using these EDM modes a narrow visible red laser beam is used to measure distances.
	<p>Telescope Type 2</p> <ul style="list-style-type: none"> • When measuring distances to a reflector with EDM mode "IR" this telescope type uses a wide visible red laser beam, which emerges coaxially from the telescope's objective. • Instruments that are equipped with a reflectorless EDM additionally offer the EDM modes "RL" and "LO". When using these EDM modes a narrow visible red laser beam is used to measure distances.

Available
documentation

Name	Description and Format		
User Manual	All instructions required in order to operate the product to a basic level are contained in the User Manual. Provides an overview of the product together with technical data and safety directions.	✓	✓

Name	Description and Format		
System Field Manual	Describes the general working of the product in standard use. Intended as a quick reference field guide.		✓
Applications Field Manual	Describes specific onboard application programs in standard use. Intended as a quick reference field guide.	✓	✓
Technical Reference Manual	Overall comprehensive guide to the product and program functions. Included are detailed descriptions of special software/hardware settings and software/hardware functions intended for technical specialists.		✓

Refer to the following resources for all TPS1200 documentation and software:

- the SmartWorx DVD
 - <http://www.leica-geosystems.com/downloads>
-

Table of Contents

In this manual

Chapter	Page
1 Description of the System	12
1.1 System Components	12
1.2 System Concept	19
1.2.1 Software Concept	19
1.2.2 Data Storage and Data Conversion Concept	21
1.2.3 Power Concept	23
1.3 Container Contents	24
1.4 Instrument Components	28
2 User Interface	32
2.1 Keyboard	32
2.2 Screen	36
2.3 Operating Principles	38
2.4 Icons	44
3 Operation	50
3.1 Instrument Setup	50
3.2 Autodetect Behaviour	53
3.3 Instrument Setup as SmartStation	55

3.3.1	SmartStation Setup	55
3.3.2	LED Indicators on SmartAntenna	59
3.3.3	Working with the Clip-On-Housings for Devices	61
3.3.4	LED Indicators on Clip-On-Housings	65
3.4	Instrument Setup for Remote Control	69
3.4.1	Remote Control Setup	69
3.4.2	LED Indicators on RadioHandle	71
3.5	Battery	73
3.5.1	Operating Principles	73
3.5.2	Instrument Battery	75
3.5.3	SmartAntenna Battery	77
3.6	Working with the CompactFlash Card	79
3.7	Accessing Survey Application Program	82
3.8	Guidelines for Correct Results	85
4	Check & Adjust	88
4.1	Overview	88
4.2	Preparation	92
4.3	Combined Adjustment (l, t, i, c and ATR)	94
4.4	Tilting Axis Adjustment (a)	99
4.5	Adjustment of the Circular Level	104
4.6	Adjustment of the Reflectorless EDM	107
4.7	Adjustment of the Laser Plummet	112
4.8	Service of the Tripod	116

5	Care and Transport	118
5.1	Transport	118
5.2	Storage	120
5.3	Cleaning and Drying	121
5.4	Maintenance	122
6	Safety Directions	124
6.1	General Introduction	124
6.2	Intended Use	125
6.3	Limits of Use	127
6.4	Responsibilities	128
6.5	International Warranty, Software Licence Agreement	129
6.6	Hazards of Use	131
6.7	Laser Classification	137
6.7.1	Integrated Distancer, Measurements with Reflectors (IR mode)	137
6.7.2	Integrated Distancer, Measurements without Reflectors (RL mode)	140
6.7.3	Automatic Target Recognition ATR	147
6.7.4	PowerSearch PS	149
6.7.5	Electronic Guide Light EGL	151
6.7.6	Laser Plummet	153
6.8	Electromagnetic Compatibility EMC	157
6.9	FCC Statement, Applicable in U.S.	160

7	Technical Data	168
7.1	Angle Measurement	168
7.2	Distance Measurement with Reflectors (IR mode)	169
7.3	Distance Measurement without Reflectors (RL mode)	172
7.4	Distance Measurement - Long Range (LO mode)	175
7.5	Automatic Target Recognition ATR	177
7.6	PowerSearch PS	180
7.7	SmartStation	181
7.7.1	SmartStation Accuracy	181
7.7.2	SmartStation Dimensions	183
7.7.3	SmartAntenna Technical Data	184
7.8	Conformity to National Regulations	188
7.8.1	Communication side cover with Bluetooth	188
7.8.2	GFU24, Siemens MC75	189
7.8.3	GFU19 (US), GFU25 (CAN) CDMA MultiTech MTMMC-C	191
7.8.4	RadioHandle	193
7.8.5	SmartAntenna with Bluetooth	195
7.9	General Technical Data of the Instrument	197
7.10	Scale Correction	204
7.11	Reduction Formulas	211
	Index	216

1 Description of the System

1.1 System Components

Main components

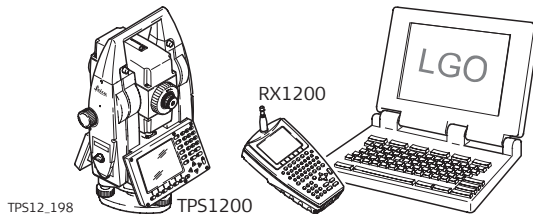

Component	Description
TPS1200	<ul style="list-style-type: none">• an instrument for measuring, calculating and capturing data.• comprised of various models with a range of accuracy classes.• integrated with an add-on GNSS system to form SmartStation.• combined with RX1200 to conduct remote control surveys.• connected with LGO to view, exchange and manage data.

Component	Description
RX1200	A multi-purpose controller enabling the remote control of TPS1200.
LGO	An office software consisting of a suite of standard and extended programs for the viewing, exchange and management of data.

Terminology

The following terms and abbreviations may be found in this manual:

Term	Description
TPS	T otal S tation P ositioning S ystem
GNSS	G lobal N avigation S atellite S ystem (generic term for satellite based navigation systems like GPS, GLONASS, SBAS)
RCS	R emote C ontrol S urveying
LGO	L EICA G eo O ffice
EDM	E lectronic D istance M easurement EDM refers to the laser distancer incorporated into the instrument which enables distance measurement.

Term	Description
	<p>Three measuring modes are available:</p> <ul style="list-style-type: none">• IR mode. This mode refers to the ability to measure distances to prisms.• RL mode. This mode refers to the ability to measure distances without prisms.• LO mode. This mode refers to the visible red laser and the ability to measure extended distances to prisms.
PinPoint	PinPoint refers to the Reflectorless EDM technology which enables an increased measuring range with a smaller laser spot size. Two options are available: R100 and R300.
EGL	<p>Electronic Guide Light</p> <p>An EGL fitted to an instrument assists with prism targeting. It consists of two differently coloured flashing lights located in the instrument telescope housing. The person holding the prism can align him/herself into the instrument's line of sight.</p>
Motorised	Instruments fitted with internal motors, enabling automatic horizontal and vertical turning are referred to as Motorised .
ATR	Automatic Target Recognition

Term	Description
	ATR refers to the instrument sensor which enables the automatic fine pointing to a prism.
Automated	<p>Instruments fitted with ATR are referred to as Automated.</p> <p>Three automation modes are available with ATR:</p> <ul style="list-style-type: none"> • None: no ATR - no automation and no tracking. • ATR: automatic fine pointing to a prism. • LOCK: automatic tracking of an already targeted prism.
PowerSearch	PowerSearch refers to the instrument sensor which enables the automatic rapid finding of a prism.
SmartStation	<p>A TPS1200 instrument integrated with an add-on GNSS system, comprising hardware and software components, forms SmartStation.</p> <p>Components of SmartStation include SmartAntenna, SmartAntenna Adapter with attached clip-on-housing and antenna for a communication device and Communication side cover.</p> <p>SmartStation provides an additional instrument set-up method for determining instrument station coordinates.</p>

Term	Description
	The GNSS principles and functionality of SmartStation derive from the principles and functionality of GPS1200 instruments.
SmartAntenna	SmartAntenna with integrated Bluetooth is a component of SmartStation. It can also be used independently on a pole, with a GNSS receiver and remote controller.
RadioHandle	A component of RCS is RadioHandle. It is both an integrated radio modem with attached antenna and instrument carry handle.
Communication side cover	Communication side cover with integrated Bluetooth is a component of SmartStation. In combination with RadioHandle it is also a component of RCS.

Instrument models

Model	Description
TC1200	Basis electronic tachymeter.
TCR1200	Additional components: Reflectorless EDM.
TCRM1200	Additional components: Reflectorless EDM, Motorised.
TCA1200	Additional components: Automated, Motorised.

Model	Description
TCP1200	Additional components: Automated, Motorised, PowerSearch .
TCRA1200	Additional components: Reflectorless EDM , Automated, Motorised.
TCRP1200	Additional components: Reflectorless EDM , Automated, Motorised, PowerSearch .

LEICA Geo Office

- LGO supports GPS1200 and TPS1200 instruments. It also supports all other Leica TPS instruments.
- LGO is based on a graphical user interface with standard Windows® operating procedures.
- LGO provides the following functionality:

Functionality	Description
Standard Functionality	Includes data exchange between computer and instrument, data management including viewing and editing, reporting, creation and management of codelists, creation and use of format files for data conversion, uploading and deleting of system software and application programs.

Functionality	Description
Extended Functionality	Includes Coordinate transformations, GPS and GLONASS post processing, Level data processing, Network adjustment, GIS and CAD Export.

- Supported operating systems: Windows® XP, Windows® 2000.
 - Refer to the online help of LGO for additional information.
-

1.2 System Concept

1.2.1 Software Concept

Description

TPS1200 instruments use the same software concept.

Software type

Software type	Description
System software	<p>This software comprises the central functions of the instrument. It is also referred to as firmware.</p> <p>The programs Survey and Setup are integrated into the firmware and cannot be deleted.</p> <p>The English language is integrated into the firmware and cannot be deleted.</p>
Language software	<p>Numerous languages are available for the TPS1200 instruments. This software is also referred to as system language.</p> <p>The system software enables a maximum of three languages which can be stored at any one time - the English language and two other languages. The English language is the default language and cannot be deleted. One language is chosen as the active language.</p>

Software type	Description
Application programs	A suite of optional survey-specific application programs are available for the instrument. Some of the programs are activated freely and require no licence key and others require purchasing and are only activated with a licence key.
Customised application programs	Customised software specific to user requirements can be developed using the GeoC++ development kit. Information on the GeoC++ development environment is available on request from a Leica Geosystems representative.

Software upload

All instrument software is stored in the System RAM of the instrument. The software can be uploaded onto the instrument using the following methods:

- Using LGO the software is transferred via the serial interface to the Compact-Flash card in the instrument, which is then stored to the System RAM.
 - By connecting the CompactFlash card directly to the computer either via an internal card slot housing or an external OMNI drive, the software is transferred to the card, which is then stored to the System RAM.
-

1.2.2 Data Storage and Data Conversion Concept

Description

Data is stored within a job in a database on a memory device. This is either a CompactFlash card or an internal memory if fitted.

Memory device

CompactFlash card:

A CompactFlash card housing is standard. A CompactFlash card can be inserted and removed. Various storing capacities are available.



Whilst other CompactFlash cards may be used, Leica recommends Leica CompactFlash cards and cannot be held responsible for data loss or any other error that may occur when using a non-Leica card.

Internal memory:

An internal memory is optional. It resides inside the instrument. Available capacity: 64 MB.



Unplugging connecting cables or removing the CompactFlash card during the measurement may cause loss of data. Always return to **TPS1200 Main Menu** before removing the CompactFlash card and switch off the instrument before removing cables.

Data conversion**Export**

Data can be exported from a job in a wide range of ASCII formats. The export format is defined in Format Manager which is a PC tool in LEICA Geo Office. Refer to the online help of LGO for information on creating format files.

Data can also be exported from a job in DXF format.

Import

Data can be imported from ASCII, DXF, GSI8 or GSI16 format.

Transfer raw data to LGO

Raw data can be transferred between the database on the CompactFlash card or the internal memory of the instrument and LGO in two ways:

- From the CompactFlash card or the internal memory directly via a serial interface to a project in LGO on a PC.
 - From the CompactFlash card using for example an OMNI drive as supplied by Leica Geosystems to a project in LGO on a PC.
-



CompactFlash cards can be used directly in an OMNI drive as supported by Leica Geosystems. Other PC card drives may require an adapter.

1.2.3 Power Concept

General

Use the Leica Geosystems batteries, chargers and accessories or accessories recommended by Leica Geosystems to ensure the correct functionality of the instrument.

Power options

Instrument

Power for the instrument can be supplied either internally or externally. An external battery is connected to the instrument using a LEMO cable.

Internal battery: One GEB221 battery fitted into the battery compartment.

External battery: One GEB171 battery connected via cable, or

SmartAntenna

Power for the antenna is supplied internally.

Internal battery: One GEB211 battery fitted into the antenna.

1.3 Container Contents

**Container for instrument and delivered accessories
part 1 of 2**

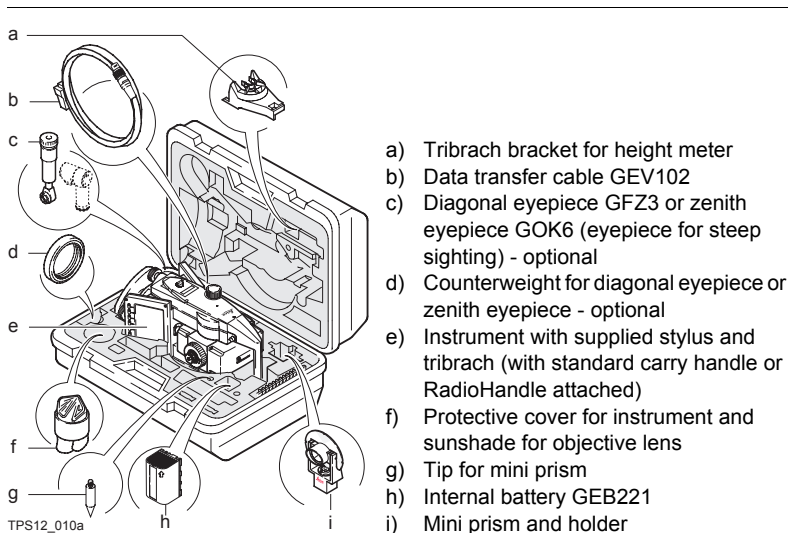

**Container for
instrument and
delivered
accessories
part 2 of 2**

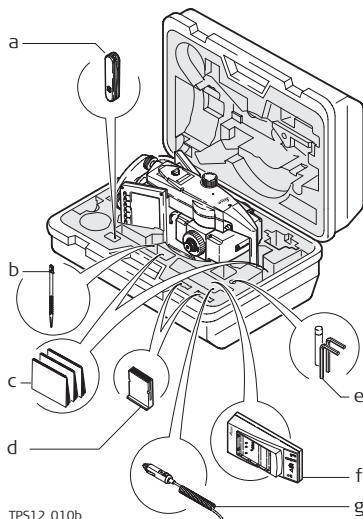

- a) Pocket knife - optional
- b) Spare stylus
- c) User manual
- d) 2 x CompactFlash cards and covers
- e) Tool set for circular level and EDM adjustments - comprising two adjusting pins, one allen key and one screwdriver
- f) Battery charger
- g) Car adapter power plug for battery charger (stored under battery charger)

**Container for
System 1200
components
part 1 of 2**

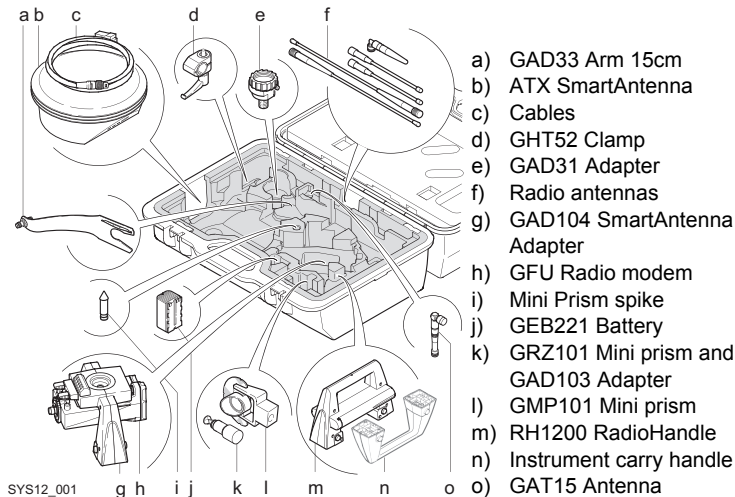

**Container for
System 1200
components
part 2 of 2**

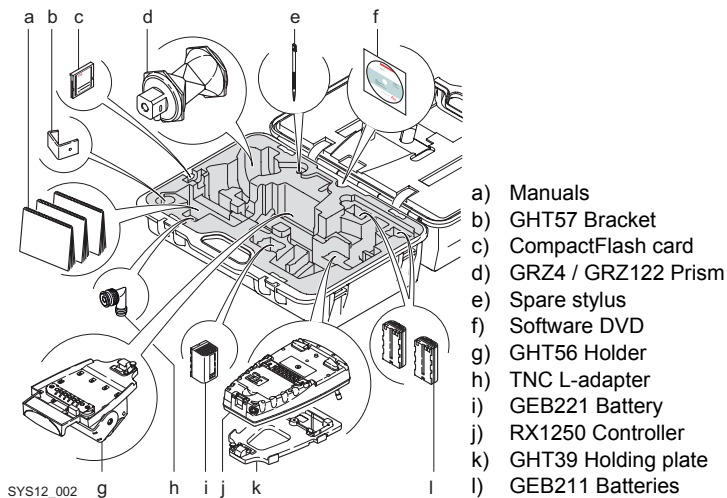

1.4 Instrument Components

Instrument components part 1 of 2

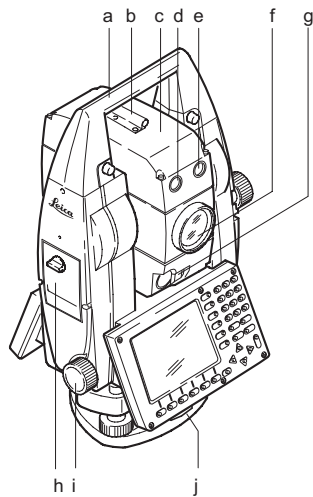

TPS12_001a

- a) Carry handle
- b) Optical sight
- c) Telescope, integrating EDM, ATR, EGL, PS
- d) EGL flashing diode - yellow
- e) EGL flashing diode - red
- f) Coaxial optics for angle and distance measurement, and exit port of visible laser beam for reflectorless instruments
- g) PowerSearch
- h) CompactFlash card compartment
- i) Horizontal drive
- j) Tribrach securing screw

Instrument components part 2 of 2

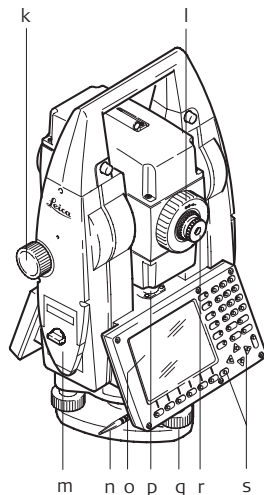

TPS12_001b

- k) Vertical drive
- l) Focusing ring
- m) Battery compartment
- n) Stylus for touch screen
- o) Screen
- p) Circular level
- q) Tribrach footscrew
- r) Interchangeable eyepiece
- s) Keyboard

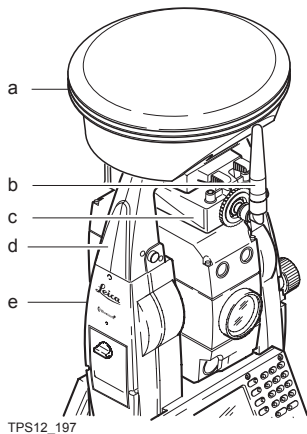
**Instrument
components for
SmartStation**

TPS12_197

- a) SmartAntenna
- b) Antenna for communication device
- c) Clip-on-housing for communication device
- d) SmartAntenna Adapter
- e) Communication side cover

Instrument components for RCS

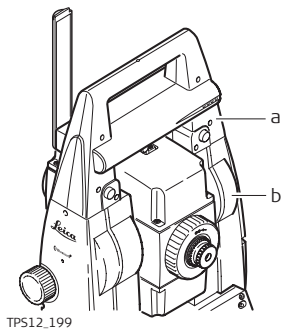

- a) RadioHandle
 - b) Communication side cover
-

2 User Interface

2.1 Keyboard

Keyboard

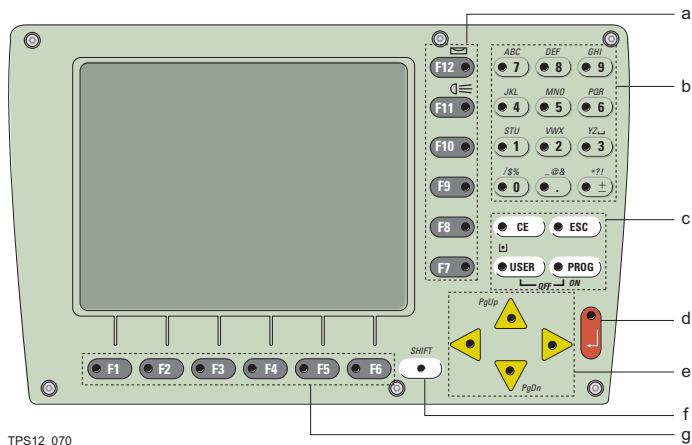

- a) Hot keys **F7-F12**
- b) Alphanumeric keys
- c) **CE, ESC, USER, PROG**
- d) **ENTER**
- e) Arrow keys
- f) **SHIFT**
- g) Function keys **F1-F6**

Keys

Key	Description
Hot keys F7-F12	<ul style="list-style-type: none"> • User definable keys to execute commands or access chosen screens.
Alphanumeric keys	<ul style="list-style-type: none"> • To type letters and numbers.
CE	<ul style="list-style-type: none"> • Clears all entry at the beginning of user input. • Clears the last character during user input.
ESC	<ul style="list-style-type: none"> • Leaves the current menu or dialog without storing changes made.
USER	<ul style="list-style-type: none"> • Calls the user defined menu.
PROG (ON)	<ul style="list-style-type: none"> • If the instrument is off: to turn instrument on. • If the sensor is on: press at any time to select an application program.

Key	Description
ENTER	<ul style="list-style-type: none">• Selects the highlighted line and leads to the next logical dialog/menu.• Starts the edit mode for edit fields.• Opens a list box.
SHIFT	<ul style="list-style-type: none">• Changes between the first and the second level of function keys.
Arrow keys	<ul style="list-style-type: none">• Move the focus on the screen.
Function keys F1-F6	<ul style="list-style-type: none">• Correspond to the six softkeys that appear on the bottom of the screen when the screen is activated.

Key combinations

Keys	Description
PROG plus USER	Turns instrument off.
SHIFT F12	Calls STATUS Level & Laser Plummet.
SHIFT F11	Calls CONFIGURE Lights, Display, Beeps, Text, Lights page.
SHIFT USER	Calls QUICK SET Change Settings to:.

Keys	Description
SHIFT ▲	Pages up.
SHIFT ▼	Pages down.

2.2 Screen

Screen

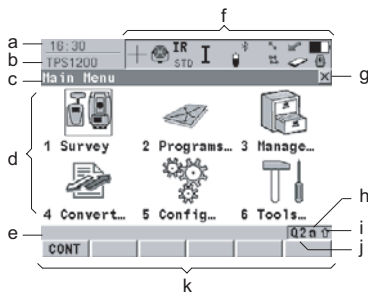

TPS12_081

- a) Time
- b) Caption
- c) Title
- d) Screen area
- e) Message line
- f) Icons
- g) ESC ☒
- h) CAPS
- i) SHIFT icon
- j) Quick coding icon
- k) Softkeys

Elements of the screen

Element	Description
Time	The current local time is shown.
Caption	Shows location either in Main Menu , under PROG key or USER key.
Title	Name of the screen is shown.
Screen area	The working area of the screen.

Element	Description
Message line	Messages are shown for 10 s.
Icons	Shows current status information of the instrument. Refer to "2.4 Icons". Can be used with touch screen.
ESC ☒	Can be used with touch screen. Same functionality as the fixed key ESC . The last operation will be undone.
CAPS	The caps mode for upper case letters is active. The caps mode is activated and deactivated by pressing UPPER (F5) or LOWER (F5) in some screens.
SHIFT icon	Shows the status of the SHIFT key; either first or second level of softkeys is selected. Can be used with touch screen and has the same functionality as the fixed key SHIFT .
Quick coding icon	Shows the quick coding configuration. Can be used with touch screen to turn quick coding on and off.
Softkeys	Commands can be executed using F1-F6 keys. The commands assigned to the softkeys are screen dependent. Can be used directly with touch screen.
Scroll bar	Scrolls the screen area up and down.

2.3 Operating Principles

Keyboard and touch screen

The user interface is operated either by the keyboard or by the touch screen with supplied stylus. The workflow is the same for keyboard and touch screen entry, the only difference lies in the way information is selected and entered.

Turn instrument on

Press and hold **PROG** for 2 s.

Turn instrument off step-by-step

Step	Description
	The instrument can only be turned off in TPS1200 Main Menu .
1.	Press and hold both USER and PROG simultaneously.
2.	Press YES (F6) to continue or NO (F4) to cancel.

Lock/Unlock keyboard

Option	Description
Lock	To lock the keyboard press and hold SHIFT for 3 s. The message 'Keyboard locked' is momentarily displayed on the Message Line.
Unlock	To unlock the keyboard press and hold SHIFT for 3 s. The message 'Keyboard unlocked' is momentarily displayed on the Message Line.

Selecting from a menu

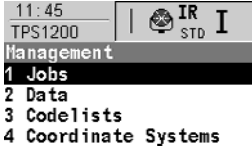
Appearance	Description
 <p>The screenshot shows the top status bar with '11:45' and 'TPS1200'. Below it is a navigation bar with a globe icon, 'IR', 'STD', and 'I'. The main menu is titled 'Management' and lists four options: '1 Jobs' (highlighted), '2 Data', '3 Codelists', and '4 Coordinate Systems'.</p>	<p>To select an item from a menu, do one of the following:</p> <ul style="list-style-type: none">Move the focus to the item. ENTER or CONT (F1). <p>OR</p> <ul style="list-style-type: none">Type the complete selection number in front of the item. ENTER or CONT (F1) are not required. <p>OR</p> <ul style="list-style-type: none">Tap on the item with the stylus.

Selecting a page

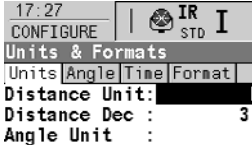
Appearance	Description
 <p>The screenshot shows the top status bar with '17:27' and 'CONFIGURE'. Below it is a navigation bar with a globe icon, 'IR', 'STD', and 'I'. The main page is titled 'Units & Formats' and has four tabs: 'Units', 'Angle', 'Time', and 'Format'. Under the 'Units' tab, the following settings are shown: 'Distance Unit:' (highlighted), 'Distance Dec : 3', and 'Angle Unit :'.</p>	<p>To select a page in a screen, do one of the following:</p> <ul style="list-style-type: none">PAGE (F6). <p>OR</p> <ul style="list-style-type: none">Tap on the page tab with the stylus.

**Edit an entire value
in input fields**

Appearance	Description
	<ol style="list-style-type: none">1. Highlight the field.2. Type numeric and/or alphanumeric characters to overwrite.3. ENTER or tap outside of the field.

**Edit an individual
character in input
fields**

Appearance	Description
	<p>A character can be inserted or overwritten. The procedure is the same for both cases.</p> <ol style="list-style-type: none">1. Highlight the field.2. For the keyboard: ENTER. The edit mode is activated where additional functions like insert and overwrite are available.3. For the touch screen: Highlight the characters to be changed.4. Type numeric and/or alphanumeric characters.5. ENTER or tap outside of the field.

Access special alphanumeric characters for input

Step	Description
1.	Highlight the input field.
2.	For the keyboard: ENTER .
3.	Toggle to the desired special character set by using the up/down arrow keys.
4.	Press the function key assigned to the required character group.
5.	Press the function key with the required character.
6.	Repeat step 4. and 5. for entering more special characters of the same character set.
7.	ENTER .

Appearance and selection from a choicelist

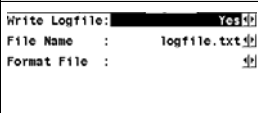

Choicelists have various appearances.

Closed choicelist



Appearance	Description	Selection
	Triangles on the right indicate further available choices.	Use the arrow keys ◀ ▶ to change through the list or tap the triangles on the screen.

ENTER or tap on the field to access the choicelist. Opening a choicelist reveals either a simple listbox or a comprehensive listbox dialog.

Simple listbox

Appearance	Description	Selection
Date Format : Day.Month.Year  Date : 18.11.05	<ul style="list-style-type: none">• Choicelist shows items to select.• A search field is shown if necessary.• A scroll bar is shown if necessary.	<ul style="list-style-type: none">• Highlight the item and ENTER.• To exit without changes ESC, tap  or outside the simple listbox.

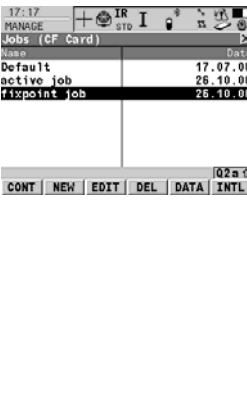
Listbox dialog

Appearance	Description	Selection
	<ul style="list-style-type: none">• Choicelist fills the whole screen.• A search field is shown.• A scroll bar is shown if necessary.• The functionality comprise adding, editing and deleting of items.• Listbox dialogs are explained in detail at appropriate places in the manuals.	<ul style="list-style-type: none">• Highlight the item and CONT (F1).• To exit without changes press ESC or tap .

2.4 Icons

Description

The screen icons display the current status information of the instrument.

Position of the icons on the screen

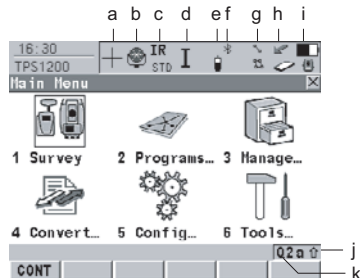

TPS12_172

- a) ATR/LOCK/PS
- b) Reflector
- c) EDM
- d) Compensator/face I&II
- e) RCS
- f) Bluetooth
- g) Line/area
- h) CompactFlash card/internal memory
- i) Battery
- j) **SHIFT**
- k) Quick coding

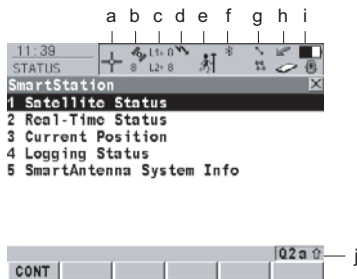

TPS12_172a

- a) GNSS position status
- b) Number of visible satellites
- c) Contributing satellites
- d) Real-time device and real-time status, Internet online status
- e) Position mode
- f) Bluetooth
- g) Line/area
- h) CompactFlash card/internal memory
- i) Battery
- j) **SHIFT**
- k) Quick coding

TPS specific icons

Icon	Description
ATR/LOCK/PS	The currently active ATR/LOCK/PS settings or searches are displayed.
Reflector	The currently active reflector is displayed.
EDM	The currently active EDM measurement settings are displayed.

Icon	Description
Compensator/face I&II	Compensator off, out of range or face I&II icon is displayed.
RCS	RCS settings are displayed.

GPS specific icons

Icon	Description
GNSS Position status	Displays the status of the current position. As soon as this icon becomes visible the receiver is in a stage where practical operation can commence.
Number of visible satellites	Displays the number of theoretically visible satellites above the configured cut off angle according to the current almanac.
Contributing satellites	Displays the number of satellites that are contributing to the currently computed position solution.

Icon	Description
	 The number of contributing satellites can differ from the number of visible satellites. This may be either because satellites cannot be viewed or the observations to these satellites are considered to be too noisy to be used in the position solution.
Real-time device and real-time status	Displays the real-time device configured to be used and its status.
Internet online status	Receiver is online in the Internet.
Position mode	Displays the current position mode.

Common icons

Icon	Description
Bluetooth	The status of each Bluetooth port and any Bluetooth connection is displayed.
Line/area	The number of lines and areas currently open in the active job is displayed.

Icon	Description
CompactFlash card/internal memory	The status of the CompactFlash card and internal memory if fitted are displayed. <ul style="list-style-type: none">• For the CompactFlash card, the capacity of used space is shown in seven levels.• For the internal memory if fitted, the capacity of used memory is shown in nine levels.
Battery	The status and source of the battery is displayed. The percentage of remaining power capacity for all batteries are displayed numerically and graphically. For internal and external battery being attached at the same time the internal battery is used until it is empty and then the external battery is used.
SHIFT	The status of the SHIFT key is displayed.
Quick coding	Shows the quick coding configuration. Can be used with touch screen to turn quick coding on and off.

3 Operation

3.1 Instrument Setup

Description

This topic describes an instrument setup over a marked ground point using the laser plummet. It is always possible to set up the instrument without the need for a marked ground point.



Important features:

- It is always recommended to shield the instrument from direct sunlight and avoid uneven temperatures around the instrument.
- The laser plummet described in this topic is built into the vertical axis of the instrument. It projects a red spot onto the ground, making it appreciably easier to centre the instrument.
- The laser plummet cannot be used in conjunction with a tribrach equipped with an optical plummet.
- Refer to "TPS1200 Technical Reference Manual" for additional information on using the laser plummet.

Setup step-by-step

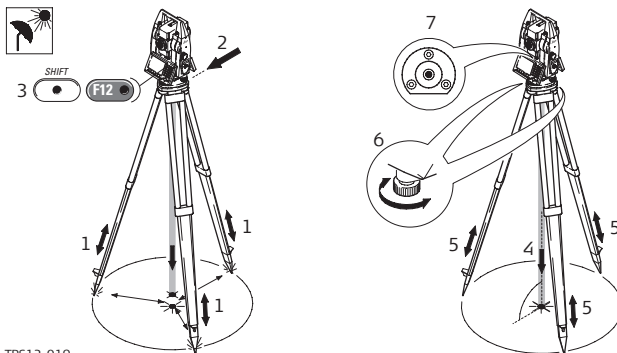

TPS12_019

Step	Description
	Shield the instrument from direct sunlight and avoid uneven temperatures around the instrument.
1.	Extend the tripod legs to allow for a comfortable working posture. Position the tripod over the marked ground point, centring it as well as possible.
2.	Fasten the tribrach and instrument onto the tripod.

Step	Description
3.	Turn on the instrument by pressing PROG for 2 s. Press SHIFT (F12) to access STATUS Level & Laser Plummet , activating the laser plummet.
4.	Move the tripod legs (1) and use the tribrach footscrews (6) to centre the plummet (4) over the ground point.
5.	Adjust the tripod legs to level the circular level (7).
6.	By using the electronic level turn the tribrach footscrews (6) to precisely level the instrument.
7.	Centre the instrument precisely over the ground point (4) by shifting the tribrach on the tripod plate (2).
8.	Repeat steps 6. and 7. until the required accuracy is achieved.

3.2 Autodetect Behaviour

Description

- The instrument incorporates an autodetect behaviour and automatically detects the following devices:
 - SmartAntenna
 - RadioHandle
 - radios/modems in clip-on-housings
- Whenever a device is attached, the instrument responds with two short beeps.
- Whenever a device is removed, the instrument responds with one long beep.

SmartAntenna Adapter

- SmartAntenna Adapter cannot be detected by the instrument but the devices that are attached to SmartAntenna Adapter are automatically detected. These devices are SmartAntenna and radios/modems in clip-on-housings.

Radio/Modem in clip-on housing

- All radios and modems that are built into a clip-on housing are automatically detected by the instrument when attached to SmartAntenna Adapter, but the device settings are not automatically set.

SmartAntenna

- SmartAntenna is automatically detected by the instrument when it is attached and **STATUS Interfaces** is automatically updated.
- Certain functionality can only be executed if SmartAntenna is attached.

-
- In addition to the autodetect behaviour, SmartAntenna can also be manually turned on/off using the ON/OFF button located on the underside. This action overrides all automatic settings but is only possible when SmartAntenna is fitted with an internal battery.
 - If turned off, SmartAntenna is automatically turned on:
 - by the Setup application, when **<Station Coord: From GPS>**
 - by the GPS Survey application, in the **GPS SURVEY** screen.
 - in the **STATUS SmartStation** menu
-



RadioHandle

- RadioHandle is automatically detected by the instrument when it is attached.
 - When RadioHandle is attached and RCS Mode is activated via the quick settings in **SHIFT USER**, the appropriate port and device settings are set.
-

3.3 Instrument Setup as SmartStation

3.3.1 SmartStation Setup

Setup step-by-step

Step	Description
	Refer to "3.5 Battery" to change the internal battery of the SmartAntenna.
	Refer to "3.1 Instrument Setup" for the initial instrument setup onto a tripod. Remove the instrument carry handle by simultaneously pressing and holding-in the four push buttons.

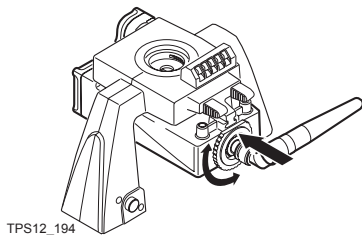

Step	Description
1.	A circular screw is located at one end of the clip-on-housing. Ensure that the circular screw is in the unlocked position. Turn it anticlockwise, as shown by the lock and arrow symbols on the screw.
2.	Slide the clip-on-housing into position underneath the SmartAntenna Adapter, such that the guide rails on the clip-on-housing and the guide rails on the SmartAntenna Adapter are aligned.
	Ensure that the connector located at the end of the clip-on-housing fits into its port of the SmartAntenna Adapter.
3.	Lock the circular screw by turning it clockwise, as shown by the lock and arrow symbols on the screw. The clip-on-housing is now locked into position.
4.	Thread the antenna onto the clip-on-housing.

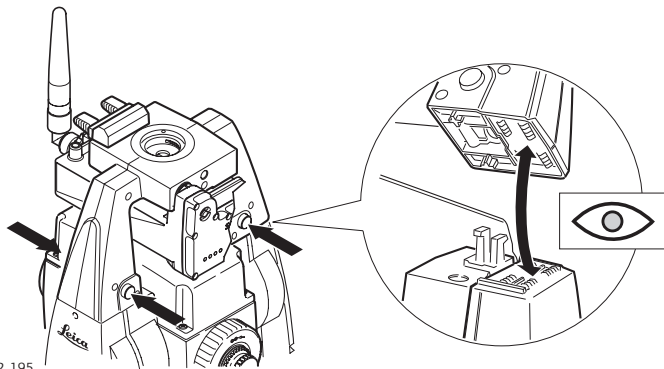

TPS12_195

Step	Description
5.	Place the SmartAntenna Adapter with attached clip-on-housing onto the instrument by simultaneously pressing and holding-in the four push buttons.
	Ensure that the interface connection on the underside of the SmartAntenna Adapter is on the same side as the Communication side cover.

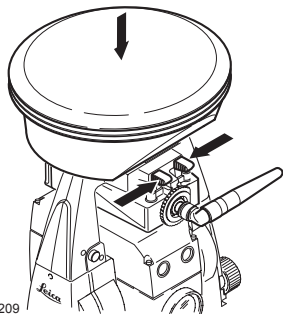

TPS12_209

Step	Description
6.	Place the SmartAntenna onto the SmartAntenna Adapter by simultaneously pressing and holding-in the two press clips.
	Ensure that the clip-on-contacts on the underside of the SmartAntenna are aligned to the clip-on-contacts of the SmartAntenna Adapter.

3.3.2 LED Indicators on SmartAntenna

LED Indicators

Description

SmartAntenna has Light Emitting Diode indicators. They indicate the basic antenna status.

Diagram of LED Indicators

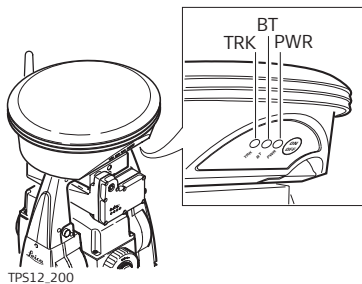

TRK	Tracking LED
BT	Bluetooth LED
PWR	Power LED

Description of LED Indicators

IF the	is	THEN
TRK	off	no satellites are tracked.
	flashing green	less than four satellites are tracked, a position is not yet available.
	green	enough satellites are tracked to compute a position.
	red	SmartAntenna is initialising.
BT	green	Bluetooth is in data mode and ready for connecting.
	purple	Bluetooth is connecting.
	blue	Bluetooth has connected.
	flashing blue	data is being transferred.
PWR	off	power is off.
	green	power is okay.
	flashing green	power is low. The remaining time for which enough power is available depends on the type of survey, the temperature and the age of the battery.

3.3.3 Working with the Clip-On-Housings for Devices

Devices fitting into a clip-on-housing

Digital cellular phones fitting into a clip-on-housing

Digital cellular phone	Clip-on-housing
Siemens MC75	GFU24
CDMA MultiTech MTMMC-C (US)	GFU19
CDMA MultiTech MTMMC-C (CAN)	GFU25

Radios fitting into a clip-on-housing

Radio	Clip-on-housing
Pacific Crest PDL, receive	GFU15
Satellite 3AS, transceive	GFU14

Attach/detach a clip-on-housing step-by-step**Attach a clip-on-housing**

Refer to "3.3.1 SmartStation Setup" for detailed information.

Detach a clip-on-housing

Step	Description
1.	A circular screw is located at one end of the clip-on-housing. To unlock and release the clip-on-housing from the SmartAntenna Adapter turn the screw anticlockwise, as shown by the lock and arrow symbols on the screw.
2.	Slide the clip-on-housing away from the SmartAntenna Adapter until the connector is completely unplugged from its port.

Insert a SIM card step-by-step

For those digital cellular phones that require SIM cards.

Step	Description
1.	Take the SIM card, a coin and a pen.
2.	Locate the SIM card screw, that covers the SIM card slot, at the end of the clip-on-housing.
3.	Insert the coin into the groove of the SIM card screw.
4.	Turn the coin anticlockwise to loosen the SIM card screw.

Step	Description
5.	Remove the SIM card screw from the housing.
6.	Using the pen, press the small button of the SIM card slot to eject the SIM card holder.
7.	Take the SIM card holder out off the housing.
8.	Put the SIM card into the SIM card holder, the chip facing up.
9.	Insert the SIM card holder into the SIM card slot, the chip facing the connectors inside the slot.
10.	Place the SIM card screw back onto the housing.
11.	Insert the coin into the groove of the SIM card screw.
12.	Turn the coin clockwise to tighten the SIM card screw.

**Remove a SIM card
step-by-step**

For those digital cellular phones that require SIM cards.

Step	Description
1.	Take a coin and a pen.
2.	Locate the SIM card screw, that covers the SIM card slot, at the end of the clip-on-housing.
3.	Insert the coin into the groove of the SIM card screw.
4.	Turn the coin anticlockwise to loosen the SIM card screw.
5.	Remove the SIM card screw from the housing.
6.	Using the pen, press the small button of the SIM card slot to eject the SIM card holder.
7.	Take the SIM card holder out off the SIM card slot.
8.	Take the SIM card out of the SIM card holder.
9.	Put the SIM card holder back into the SIM card slot, the even side not facing the contacts inside the slot.
10.	Place the SIM card screw back onto the housing.
11.	Turn the coin clockwise to tighten the SIM card screw.

3.3.4 LED Indicators on Clip-On-Housings

LED Indicators

Description

Each clip-on-housing for a radio or a digital cellular phone has Light Emitting Diode indicators. They indicate the basic device status.

Diagram of the LED Indicators

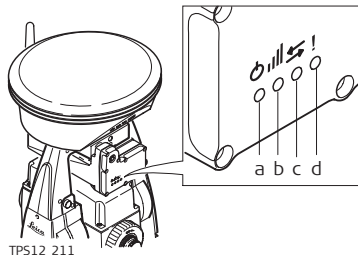

- a) Power LED
- b) Signal strength LED
- c) Data transfer LED
- d) Warning LED,
available for Sateline 3AS

Description of the LED Indicators

IF the	on	is	THEN
Warning LED	GFU14 with Satellite 3AS	red	the device is in the configuration mode controlled from the PC via cable.
Data transfer LED	any device	off	data is not being transferred.
		green or flashing green	data is being transferred.
Signal strength LED	GFU19 (US), GFU25 (CAN) with CDMA MultiTech MTMMC-C	red	device is on, not registered on the network.
		flashing red	device is on, registered on the network.
		off	download mode or device is off.

IF the	on	is	THEN
	GFU24 with Siemens MC75	red	call is in progress.
		red: long flash, long break	no SIM card inserted, no PIN entered or network search, user authentication or network login in progress.
		red: short flash, long break	logged onto network, no call in progress.
		red: flashing red, long break	GPRS PDP context activated.
		red: long flash, short break	Packet switched data transfer is in progress.
		off	device is off.

IF the	on	is	THEN
	GFU15 with Pacific Crest PDL	red or flashing red	the communication link, Data Carrier Detection , is okay on the roving receiver.
		off	the DCD is not okay.
	GFU14 with Satelline 3AS	red or flashing red	the communication link, Data Carrier Detection , is okay on the roving receiver.
		off	the DCD is not okay.
Power LED	any device	off	power is off.
		green	power is okay.

3.4 Instrument Setup for Remote Control

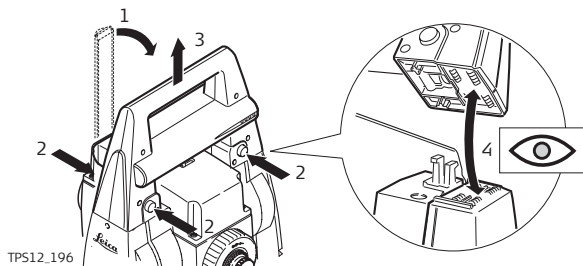

3.4.1 Remote Control Setup

Setup step-by-step



TPS12_196

Step	Description
	Refer to "3.1 Instrument Setup" for the initial instrument setup onto a tripod. Remove the instrument carry handle by simultaneously pressing and holding-in the four push buttons.
1.	Place the RadioHandle onto the instrument by simultaneously pressing and holding-in the four push buttons.

Step	Description
	Ensure that the interface connection on the underside of the RadioHandle is on the same side as the Communication side cover.
2.	Swing the RadioHandle antenna into an upright position.
	Refer to "RX1200 User Manual" for additional information.

3.4.2 LED Indicators on RadioHandle

LED Indicators

Description

The RadioHandle has Light Emitting Diode indicators. They indicate the basic RadioHandle status.

Diagram of the LED Indicators

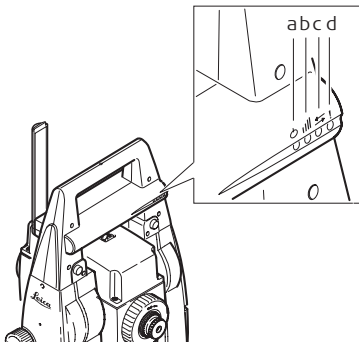

- a) Power LED
- b) Link LED
- c) Data Transfer LED
- d) Mode LED

Description of the LED Indicators

IF the	is	THEN
Power LED	off	power is off.
	green	power is on.
Link LED	off	no radio link to remote controller.
	red	radio link to remote controller.
Data Transfer LED	off	no data transfer to/from remote controller.
	green or green flashing	data transfer to/from remote controller.
Mode LED	off	data mode.
	red	configuration mode.

3.5 Battery

3.5.1 Operating Principles



Primary use/charging

- The battery must be charged prior to using it for the first time because it is delivered with an energy content as low as possible.
- For new batteries or batteries that have been stored for a long time (> three months), it is effectual to make only one charge/discharge cycle.
- For Li-Ion batteries, a single discharging and charging cycle is sufficient. We recommend carrying out the process when the battery capacity indicated on the charger or on a Leica Geosystems product deviates significantly from the actual battery capacity available.
- The permissible temperature range for charging is between 0°C to +40°C/+32°F to +104°F. For optimal charging we recommend charging the batteries at a low ambient temperature of +10°C to +20°C/+50°F to +68°F if possible.
- It is normal for the battery to become warm during charging. Using the chargers recommended by Leica Geosystems, it is not possible to charge the battery if the temperature is too high.

Operation/Discharging

- The batteries can be operated from -20°C to $+55^{\circ}\text{C}$ / -4°F to $+131^{\circ}\text{F}$.
 - Low operating temperatures reduce the capacity that can be drawn; very high operating temperatures reduce the service life of the battery.
-

3.5.2 Instrument Battery

Change battery step-by-step

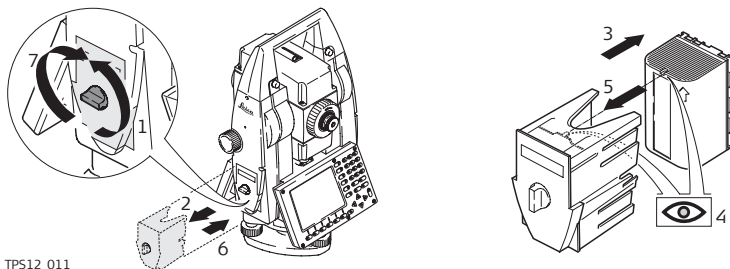

TPS12_011

Step	Description
1.	Face the instrument so that the vertical drive screw is on the left. The battery compartment is now on the left side of the instrument. Turn the knob to the vertical position, opening the lid of the battery compartment.
2.	Pull out the battery housing.
3.	Pull the battery from the battery housing.
4.	A pictogram of the battery is displayed inside the battery housing. This is a visual aid to assist in placing the battery correctly.

Step	Description
5.	Place the battery into the battery housing, ensuring that the contacts are facing outward. Click the battery into position.
6.	Place the battery housing into the battery compartment. Push the battery housing in until it fits completely into the battery compartment.
7.	Turn the knob to lock the battery compartment. Ensure that the knob is returned to its original horizontal position.

3.5.3 SmartAntenna Battery

Change battery step-by-step

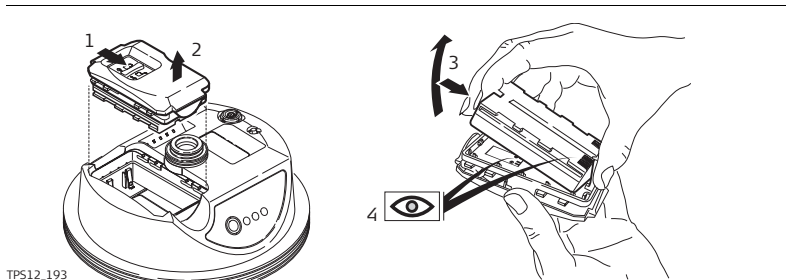

TPS12_193

Step	Description
	Turn SmartAntenna over to gain access to the battery compartment.
1.	Open the battery compartment by pushing the slide fastener in the direction of the arrow with the open-lock symbol.
2.	Pull out the battery housing. The battery is attached to the housing.
3.	Hold the battery housing and pull the battery from the battery housing.

Step	Description
4.	A polarity of the battery is displayed inside the battery housing. This is a visual aid to assist in placing the battery correctly.
5.	Place the battery onto the battery housing, ensuring that the contacts are facing outward. Click the battery into position.
6.	Close the battery compartment by pushing the slide fastener in the direction of the arrow with the close-lock symbol.

3.6 Working with the CompactFlash Card



- Keep the card dry.
- Use it only within the specified temperature range.
- Do not bend the card.
- Protect the card from direct impacts.



Failure to follow these instructions could result in data loss and/or permanent damage to the card.

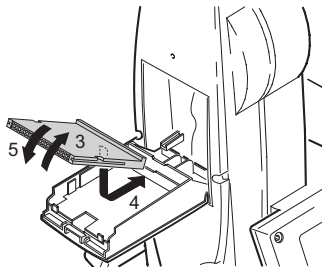
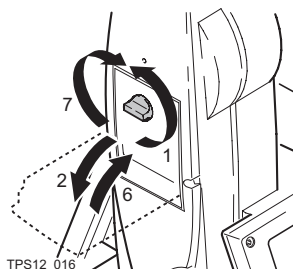

Insert and remove a CompactFlash card step-by-step



Step	Description
1.	Face the instrument so that the vertical drive screw is on the left. The CompactFlash card compartment is now on the right side of the instrument. Turn the knob to the vertical position, opening the lid of the CompactFlash card compartment.
2.	Open the lid of the CompactFlash card compartment.
3.	Pull the front of the CompactFlash card up and take the card out of the lid.
4.	Place the lower end of the CompactFlash card at the lower end of the CompactFlash card compartment. The extended edge of the card has to be on the upper side as shown on the pictogram in the CompactFlash card compartment.
5.	Press the card down on the lid.
6.	Close the lid.
7.	Turn the knob to lock the CompactFlash card compartment. The lid is closed correctly when the knob is turned to a horizontal position.

Format a CompactFlash card step-by-step

Formatting the CompactFlash card before starting to store data is required if a completely new CompactFlash card is used or if all existing data needs to be deleted.

Step	Description
1.	Main Menu: Tools...\Format Memory Device.
2.	TOOLS Format Memory Device <Memory Device: CF Card> <Format Method: Format Quick> Select the memory device to be formatted.
	By activating the format command all data will be lost. Make sure that all important data on the CompactFlash card has been backed up before formatting the card. Before formatting the internal memory make sure that all important data is first transferred to the PC.
	To exit the screen without formatting the memory device, press ESC . This returns to the previous screen without execution of any command.
3.	CONT (F1).
4.	YES (F4) to complete the formatting of the CompactFlash card.
	NO (F6) to abort the formatting of the CompactFlash card and return to TOOLS Format Memory Device.
5.	Once the formatting of the CompactFlash card is completed the system returns to TPS1200 Main Menu.

3.7 Accessing Survey Application Program

Access

Select **Main Menu: Survey**.

OR

Press **PROG**. Highlight **Survey**. **CONT (F1)**.

SURVEY

Survey Begin

11:40	+ IR STD I				Bluetooth	GPS	Light	Battery
SURVEY								
Survey Begin [X]								
Job :	active job [↵]							
Coord System :	<None>							
Codelist :	<None> [↵]							
Config Set :	survey [↵]							
Reflector :	Leica Circ Prism [↵]							
Add. Constant :	0.0 [mm]							
								Q2 a ↑
CONT	CONF	SETUP						CSYS

CONT (F1)

To accept changes and access the subsequent screen. The chosen settings become active.

CONF (F2)

To access **SURVEY Configuration**.

SETUP (F3)

Opens **SETUP Station Setup** to set station and orientation.

CSYS (F6)

To select a different coordinate system.

Description of fields

Field	Option	Description
<Job:>	Choicelist	The active job. All jobs from Main Menu: Manage...\Jobs can be selected.
<Coord System:>	Output	The coordinate system currently attached to the selected <Job:>.
<Codelist:>	Choicelist	No codes are stored in the selected <Job:>. All codelists from Main Menu: Manage...\Codelists can be selected.
	Output	Codes have already been stored in the selected <Job:>. If codes had been copied from a System RAM codelist, then the name of the codelist is displayed. If codes have not been copied from a System RAM codelist but typed in manually, then the name of the active job is displayed.
<Config Set:>	Choicelist	The active configuration set. All configuration sets from Main Menu: Manage...\Configuration Sets can be selected.

Field	Option	Description
		The instrument has numerous user configuration parameters and functions. This allows a variety of preferences to be addressed. The configuration of the parameters and functions for an individual measuring technique are combined in a configuration set.
<Reflector:>	Choicelist	Displays the active reflector. All reflectors from Main Menu: Manage...\Reflectors . All listed reflectors can be selected.
<Add. Constant:>	Output	Displays the additive constant stored with the chosen reflector.

Next step

CONT (F1) to access **SURVEY Survey: Job Name**, where measurements can be performed with **ALL (F1)** or **DIST (F2)** and/or **REC (F3)**.

3.8 Guidelines for Correct Results



Very short distances may be measured reflectorless in IR mode to well reflecting targets. Note that the distances are corrected with the additive constant defined for the active reflector.

Distance measurement

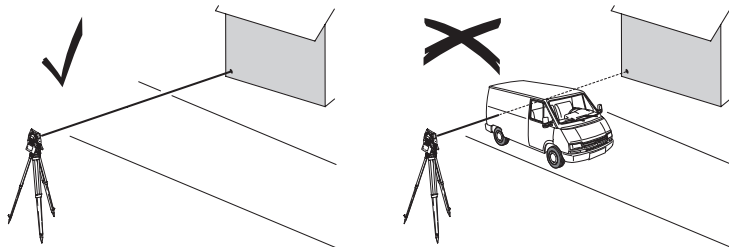

TPS12_002

When measurements are being made using the red laser EDM, the results may be influenced by objects passing between the EDM and the intended target surface. This occurs because reflectorless measurements are made to the first surface returning sufficient energy to allow the measurement to take place. For example, if the intended target surface is the surface of a road, but a vehicle passes between the EDM and the target surface as **DIST (F2)** or **ALL (F1)** is pressed, the measure-

ment may be made to the side of the vehicle. The result is the distance to the vehicle, not to the road surface.

If using the red laser EDM for long range measurements to a prism, and an object passes within 30 m of the EDM as **DIST (F2)** or **ALL (F1)** is pressed, the distance measurement may be similarly effected due to the strength of the laser signal.



Due to laser safety regulations and measuring accuracy, using the Long Range Reflectorless EDM is only allowed to prisms that are more than 1000 m (3300 ft) away.



Accurate measurements to prisms should be made in IR mode.



When a distance measurement is triggered, the EDM measures to the object which is in the beam path at that moment. If a temporary obstruction, for example a passing vehicle, heavy rain, fog or snow is between the instrument and the point to be measured, the EDM may measure to the obstruction.



Do not measure with two instruments to the same target simultaneously to avoid getting mixed return signals.

ATR/lock

Instruments equipped with an ATR sensor permit automatic angle and distance measurements to prisms. The prism is sighted with the optical sight. After initiating a distance measurement, the instrument sights the prism centre automatically.

Vertical and horizontal angles and the distance are measured to the centre of the prism. The lock mode enables the instrument to follow a moving prism.



As with all other instrument errors, the collimation error of the automatic target recognition must be redetermined periodically. Refer to "4 Check & Adjust" about checking and adjusting instruments.



When a measurement is triggered while the prism is still moving, distance and angle measurements may not be made for the same position and wrong coordinates may be calculated.



If the prism location is changed too quickly, the target may be lost. Make sure that the speed does not exceed the figure given in the technical data.

4 Check & Adjust

4.1 Overview

Description

Leica instruments are manufactured, assembled and adjusted to the best possible quality. Quick temperature changes, shock or stress can cause deviations and decrease the instrument accuracy.

It is therefore recommended to check and adjust the instrument from time to time. This can be done in the field by running through specific measurement procedures. The procedures are guided and have to be followed carefully and precisely as described in the following chapters. Some other instrument errors and mechanical parts can be adjusted mechanically.

Electronic adjustment

The following instrument errors can be checked and adjusted electronically:

l, t	Compensator longitudinal and transversal index errors
i	Vertical index error, related to the standing axis
c	Hz collimation error, also called line of sight error
a	Tilting axis error
ATR	ATR zero point error for Hz and V - option

Every angle measured in the daily work is corrected automatically if the compensator and the Hz-corrections are activated in the instrument configuration. Select **Main Menu: Config...\Instrument Settings...\Compensator** to check the settings.

View current adjustment errors

The currently used adjustment errors can be viewed under **Main Menu: Tools.../Check & Adjust.../Current Values**.

Mechanical adjustment

The following instrument parts can be adjusted mechanically:



- Circular level on instrument and tribrach
- Visible red laser beam of reflectorless EDM - option
- Laser plummet
- Optical plummet - option on tribrach
- Allen screws on tripod



- Circular level on instrument and tribrach
 - Laser plummet
 - Optical plummet - option on tribrach
 - Allen screws on tripod
-

Precise measurements

To get precise measurements in the daily work, it is important:

- To check and adjust the instrument from time to time.
- To take high precision measurements during the check and adjust procedures.

- To measure targets in two faces. Some of the instrument errors are eliminated by averaging the angles from both faces.
 - Refer to "4.2 Preparation" to find more important points.
-



During the manufacturing process, the instrument errors are carefully determined and set to zero. As mentioned above, these errors can change and it is highly recommended to redetermine them in the following situations:

- Before the first use
 - Before every high precision survey
 - After rough or long transportations
 - After long working periods
 - After long storage periods
 - If the temperature difference between current environment and the temperature at the last calibration is more than 20°C
-

Summary of errors to be adjusted electronically

Instrument error	Effects Hz	Effects V	Elimination with two face measurement	Automatically corrected with proper adjustment
c - Line of sight error	✓	---	✓	✓
a - Tilting axis error	✓	---	✓	✓
l - Compensator index error	---	✓	✓	✓
t - Compensator index error	✓	---	✓	✓
i - V-Index error	---	✓	✓	✓
ATR Collimation error	✓	✓	---	✓

4.2 Preparation



Before determining the instrument errors, the instrument has to be levelled-up using the electronic level. **SHIFT F12** to access **STATUS Level & Laser Plummet, Level** page.

The tribrach, the tripod and the underground should be very stable and secure from vibrations or other disturbances.



The instrument should be protected from direct sunlight in order to avoid thermal warming.

It is also recommended to avoid strong heat shimmer and air turbulence. The best conditions are usually early in the morning or with overcast sky.



Before starting to work, the instrument has to become acclimatised to the ambient temperature. Approximately two minutes per °C of temperature difference from storage to working environment but at least 15 min should be taken into account.



Note, that even after good adjustment of the ATR, the crosshairs might not be positioned exactly on the centre of the prism after an ATR measurement has been executed. This is a normal effect. To speed up the ATR measurement, the telescope is normally not positioned exactly on the centre of the prism. The small rest deviations, the ATR offsets are measured individually for each measurement and

corrected electronically. This means that the Hz- and V- angles are corrected twice: first by the determined ATR errors for Hz and V and then by the individual small deviations of the current pointing.

Next step

IF the task is to	THEN
adjust a combination of instrument errors	Refer to "4.3 Combined Adjustment (l, t, i, c and ATR)"
adjust the tilting axis	Refer to "4.4 Tilting Axis Adjustment (a)"
adjust the circular level	Refer to "4.5 Adjustment of the Circular Level"
adjust the EDM	Refer to "4.6 Adjustment of the Reflectorless EDM"
adjust the laser/optical plummet	Refer to "4.7 Adjustment of the Laser Plummet"
adjust the tripod	Refer to "4.8 Service of the Tripod"

4.3 Combined Adjustment (I, t, i, c and ATR)

Description

The combined adjustment procedure determines the following instrument errors in one process:



I, t	Compensator longitudinal and transversal index errors
i	Vertical index error, related to the standing axis
c	Hz collimation error, also called line of sight error
ATR Hz	ATR zero point error for Hz angle - option
ATR V	ATR zero point error for V angle - option

Combined adjustment procedure step-by-step

The following table explains the most common settings.

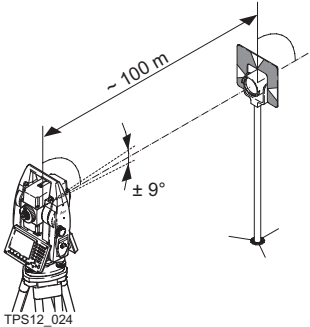
Step	Description
1.	Main Menu: Tools...\Check & Adjust...
2.	TOOLS Check & Adjust Menu
	Select the option: Combined (I,t,i,c,ATR)
3.	TOOLS Combined I

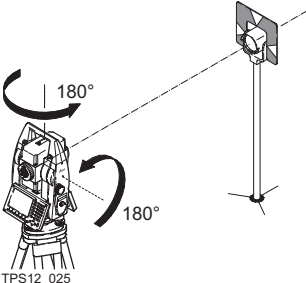
Step	Description
	<p><ATR Adjust: On> Includes the determination of the ATR Hz and V adjustment errors if an ATR is available.</p> <p> It is recommended to use a clean Leica circular prism as target. Do not use a 360° prism.</p>
4.	 <p>Aim the telescope accurately at a target at about 100 m distant. The target must be positioned within $\pm 9^\circ/\pm 10$ gon of the horizontal plane. The procedure can be started in any telescope face.</p> <p>TPS12_024</p>

Step	Description
5.	<p>MEAS (F1) to measure and to continue to the next screen.</p>  <p>Motorised instruments change automatically to the other face.</p> <p>Non-motorised instruments guide to the other face.</p> <p> The fine pointing has to be performed manually in both faces.</p> <p>TPS12_025</p>
6.	<p>TOOLS Combined II</p>
	<p>MEAS (F1) to measure the same target in the other face and to calculate the instrument errors.</p>
	<p>If one or more errors are bigger than the predefined limits, the procedure has to be repeated. All measurements of the current run are rejected and none of them is averaged with the results from previous runs.</p>
7.	<p>TOOLS Adjustment Accuracy</p>

Step	Description
	<p><No.of Meas:> Shows the number of runs executed. One run consists of a measurement in face I and face II.</p> <p><σ I Comp:> and similar lines show the standard deviations of the determined adjustment errors. The standard deviations can be calculated from the second run onwards.</p>
	<p>It is recommended to measure at least two runs.</p>
<p>8.</p>	<p>MEAS (F5) if more runs have to be added. Continue with step 3.</p> <p>OR</p> <p>CONT (F1) to accept the measurements and to proceed to TOOLS Adjustment Results. No more runs can be added later.</p>

Next step

IF the results are	THEN
to be stored	CONT (F1) overwrites the old adjustment errors with the new ones, if the Use status is set to Yes .
to be determined again	REDO (F2) rejects all new determined adjustment errors and repeats the whole procedure. Refer to step 3. of paragraph "Combined adjustment procedure step-by-step".

4.4 Tilting Axis Adjustment (a)

Description



This adjustment procedure determines the following instrument error:
a Tilting axis error

Determination of tilting axis error step-by-step

The following table explains the most common settings.

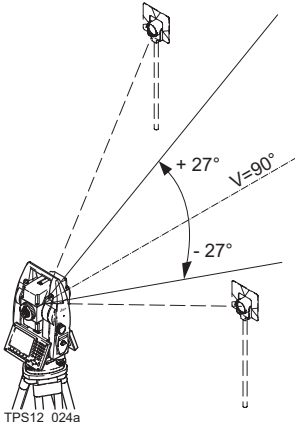
Step	Description
	The Hz collimation error (c) has to be determined before starting this procedure.
1.	Main Menu: Tools...\Check & Adjust...
2.	TOOLS Check & Adjust Menu Select the option: Tilting Axis (a)

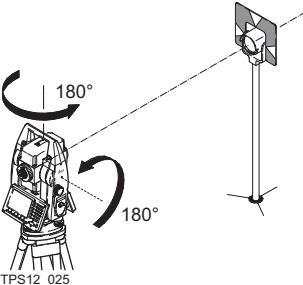
Step	Description
3.	<p data-bbox="474 166 904 194">TOOLS Tilting-Axis Adjustment I</p>  <p data-bbox="875 208 1365 373">Aim the telescope accurately at a target at about 100 m distance or less if not possible. The target must be positioned at least $27^\circ/30$ gon above or beneath the horizontal plane.</p> <p data-bbox="875 384 1326 446">The procedure can be started in any telescope face.</p> <p data-bbox="474 743 576 757">TPS12_024a</p>

Step	Description
4.	<p>MEAS (F1) to measure and to continue to the next screen.</p>  <p>Motorised instruments change automatically to the other face.</p> <p>Non-motorised instruments guide to the other face.</p> <p> The fine pointing has to be performed manually in both faces.</p> <p>TPS12_025</p>
5.	<p>TOOLS Tilting-Axis Adjustment II</p> <p>MEAS (F1) to measure the same target in the other face and to calculate the tilting axis error.</p>
	<p>If the error is bigger than the predefined limit, the procedure has to be repeated. The tilting axis measurements of the current run are then rejected and not averaged with the results from previous runs.</p>

Step	Description
6.	TOOLS T-Axis Adjustment Accuracy <No.of Meas:> Shows the number of runs executed. One run consists of a measurement in face I and face II. <σ a T-axis:> shows the standard deviation of the determined tilting axis error. The standard deviation can be calculated from the second run onwards.
	It is recommended to measure at least two runs.
7.	MEAS (F5) if more runs have to be added. Continue with step 3. OR CONT (F1) to accept the measurements and to proceed to TOOLS T-Axis Adjustment Result . No more runs can be added later.

Next step

IF the results are	THEN
to be stored	CONT (F1) overwrites the old tilting axis error with the new one.
to be determined again	REDO (F2) rejects the new determined tilting axis error and repeats the whole procedure. Refer to step 3. of paragraph "Determination of tilting axis error step-by-step".

4.5 Adjustment of the Circular Level

On the instrument
step-by-step

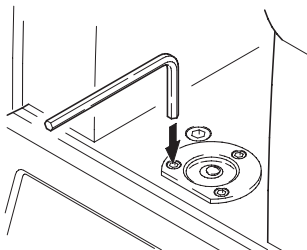

TPS12_030

Step	Description
1.	Level up the instrument in advance with the electronic level, assuming that the electronic level is correctly adjusted. SHIFT F12 to access STATUS Level & Laser Plummet .
2.	The bubble must be centered. If it extends beyond the circle, use the allen keys supplied to centre it with the adjustment screws. Turn the instrument slowly 200 gon (180°). Repeat the adjustment procedure if the bubble does not stay centered.

Step	Description
	After the adjustment, no screw shall be loose.

On the tribrach step-by-step

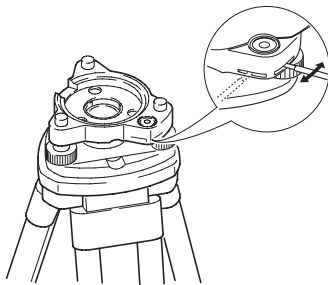

TPS12_31

The following table explains the most common settings.

Step	Description
1.	Level up the instrument with the electronic level, assuming that the electronic level is correctly adjusted. SHIFT F12 to access STATUS Level & Laser Plummet . Then remove it from the tribrach.

Step	Description
2.	The bubble of the tribrach must be centered. If it extends beyond the circle, use the adjusting pin in conjunction with the two cross headed adjustment screws to centre it.
	After the adjustment, no screw shall be loose.

4.6 Adjustment of the Reflectorless EDM

Chapter validity



This chapter is relevant for Telescope Type 1 only.

General

The red laser beam used for measuring without reflector is arranged coaxially with the line of sight of the telescope, and emerges from the objective port. If the instrument is well adjusted, the red measuring beam coincides with the visual line of sight. External influences such as shock, stress or large temperature fluctuations can displace the red measuring beam relative to the line of sight.



The direction of the beam should be inspected before precise measurements of distances are attempted, because an excessive deviation of the laser beam from the line of sight can result in imprecise distance measurements.

Warning

Direct intrabeam viewing is always hazardous.

Precautions:

Do not stare into the beam or direct it towards other people unnecessarily. These measures are also valid for the reflected beam.

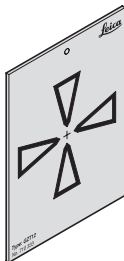

Inspecting the direction of the beam step-by-step



TPS12_36

The following table explains the most common settings.

Step	Description
1.	Set up the provided target plate between 5 m and 20 m with the grey reflective side facing the instrument.
2.	Move the telescope to face II.
3.	Switch on the red laser beam by activating the laser pointer function. SHIFT F11 to access CONFIGURE Lights, Display, Beeps, Text and then select the Lights page.

Step	Description
4.	<p>Align the instrument crosshairs to the centre of the target plate, and then inspect the position of the red laser dot on the target plate.</p> <p> Generally speaking the red dot cannot be seen through the telescope, so look at the target plate from just above the telescope or from just to the side of it.</p>
5.	<p>If the dot illuminates the cross on the plate, the achievable adjustment precision has been reached; if it lies outside the limits of the cross, the direction of the beam needs to be adjusted. Refer to paragraph "Adjusting the direction of the beam step-by-step".</p> <p> If the dot on the more reflective side of the plate is too bright and dazzling, use the white side instead to carry out the inspection.</p>

Adjusting the direction of the beam step-by-step

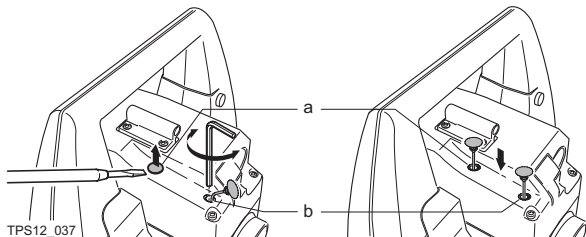

TPS12_037

- a) Rear adjustment port
b) Front adjustment port

The following table explains the most common settings.

Step	Description
1.	Pull the two plugs softly out from the adjustment ports on top side of the telescope housing in face II.  Make sure not to break the strings of the two plugs.
2.	To correct the height of the beam, insert the screwdriver supplied into the rear adjustment port and turn it clockwise to move the dot on the target plate obliquely upwards or anticlockwise to move it downwards.
3.	To correct the beam laterally, insert the screwdriver into the front adjustment port and turn it clockwise to move the dot on the target plate to the right or anticlockwise to move it to the left.

Step	Description
	Throughout the adjustment procedure, keep the telescope pointing to the target plate.
4.	After each adjustment, put back the plugs in the ports to keep out damp and dirt.

4.7 Adjustment of the Laser Plummet



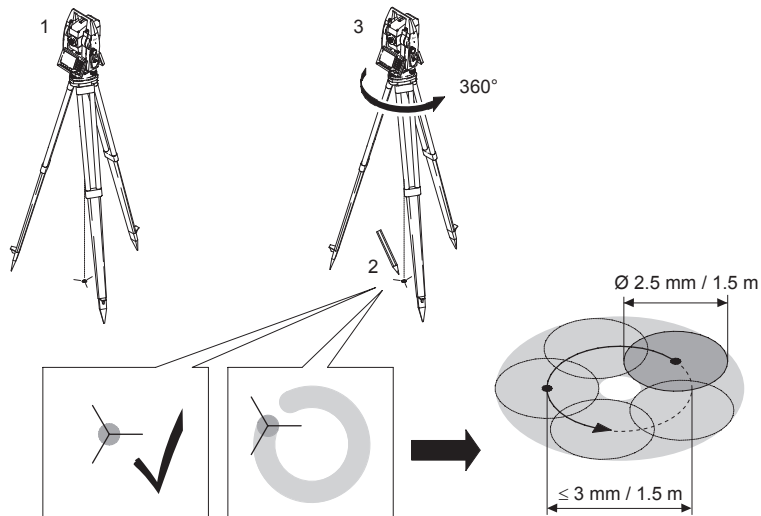

The laser plummet is located in the vertical axis of the instrument. Under normal conditions of use, the laser plummet does not need adjusting. If an adjustment is necessary due to external influences, the instrument has to be returned to any Leica Geosystems authorized service workshop.

Inspecting laser plummet step-by-step



The following table explains the most common settings.

Step	Description
1.	Setup the instrument on a tripod (1).
2.	Level up the instrument with the electronic level. SHIFT F12 to access STATUS Level & Laser Plummet .
3.	PAGE (F6) to access the Laser Plummet page. Switch on the laser plummet.
	Inspection of the laser plummet should be carried out on a bright, smooth and horizontal surface, such like a sheet of paper.
4.	Mark the centre of the red dot on the ground (2).
5.	Slowly turn the instrument through 360°, carefully observing the movement of the red laser dot (3).
	The maximum diameter of the circular movement described by the centre of the laser point should not exceed 3 mm at a distance of 1.5 m.
6.	IF the centre of the laser dot describes a perceptible circular movement or moves more than 3 mm away from the point which was first marked, an adjustment may be required. Inform your nearest Leica Geosystems authorized service workshop.

Depending on brightness and surface, the diameter of the laser dot can vary. At a distance of 1.5 m it is about 2.5 mm.

4.8 Service of the Tripod

Service tripod step-by-step

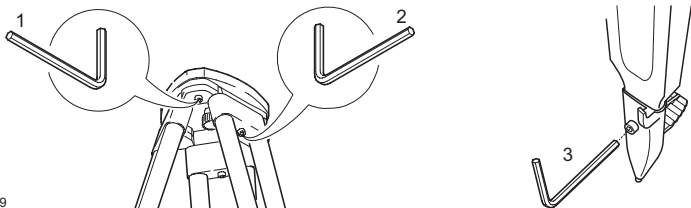

TPS12_029

The following table explains the most common settings.

Step	Description
	The connections between timber and metal must be firm and tight.
1.	Moderately tighten the allen screws (2) with the allen key supplied with the tripod.
2.	Tighten articulated joints just enough to keep the tripod legs open when lifting the tripod off the ground (1).
3.	Tighten the allen screws of the tripod legs (3).

5 Care and Transport

5.1 Transport

Transport in the field	<p>When transporting the equipment in the field, always make sure that you</p> <ul style="list-style-type: none">• either carry the product in its original transport container,• or carry the tripod with its legs splayed across your shoulder, keeping the attached product upright.
Transport in a road vehicle	<p>Never carry the product loose in a road vehicle, as it can be affected by shock and vibration. Always carry the product in its transport container and secure it.</p>
Shipping	<p>When transporting the product by rail, air or sea, always use the complete original Leica Geosystems packaging, transport container and cardboard box, or its equivalent, to protect against shock and vibration.</p>
Shipping, transport of batteries	<p>When transporting or shipping batteries, the person in charge of the product must ensure that the applicable national and international rules and regulations are observed. Before transportation or shipping, contact your local passenger or freight transport company.</p>

Field adjustment

After transport inspect the field adjustment parameters given in this user manual before using the product.

5.2 Storage

Product

Respect the temperature limits when storing the equipment, particularly in summer if the equipment is inside a vehicle. Refer to "7 Technical Data" for information about temperature limits.

Field adjustment

After long periods of storage inspect the field adjustment parameters given in this user manual before using the product.

Li-Ion batteries

- Refer to "7.9 General Technical Data of the Instrument" for information about storage temperature range.
 - A storage temperature range of -20°C to +30°C/-4°F to 68°F in a dry environment is recommended to minimize self-discharging of the battery.
 - At the recommended storage temperature range, batteries containing a 10% to 50% charge can be stored for up to one year. After this storage period the batteries must be recharged.
 - Remove batteries from the product and the charger before storing.
 - After storage recharge batteries before using.
 - Protect batteries from damp and wetness. Wet or damp batteries must be dried before storing or use.
-

5.3 Cleaning and Drying

Objective, eyepiece and prisms

- Blow dust off lenses and prisms.
 - Never touch the glass with your fingers.
 - Use only a clean, soft, lint-free cloth for cleaning. If necessary, moisten the cloth with water or pure alcohol. Do not use other liquids; these may attack the polymer components.
-

Fogging of prisms

Reflector prisms that are cooler than the ambient temperature tend to fog. It is not enough simply to wipe them. Keep them for some time inside your jacket or in the vehicle to allow them to adjust to the ambient temperature.

Damp products

Dry the product, the transport container, the foam inserts and the accessories at a temperature not greater than 40°C / 108°F and clean them. Do not repack until everything is completely dry.

Cables and plugs

Keep plugs clean and dry. Blow away any dirt lodged in the plugs of the connecting cables.

5.4 Maintenance

Motorisation

An inspection of the motorisation in motorised products must be done in a Leica Geosystems authorized service workshop.

Following conditions:

- After about 4000 hours operation.
 - Twice a year in case of permanent use of the product, for example in monitoring applications.
-

6 Safety Directions

6.1 General Introduction

Description

The following directions should enable the person responsible for the product, and the person who actually uses the equipment, to anticipate and avoid operational hazards.

The person responsible for the product must ensure that all users understand these directions and adhere to them.

6.2 Intended Use

Permitted use

- Measuring horizontal and vertical angles.
- Measuring distances.
- Recording measurements.
- Automatic target search, recognition and -tracking.
- Visualizing the aiming direction and vertical axis.
- Remote control of surveying products.
- Data transmission to external appliances.
- Transmitting and receiving data.
- Measuring raw data and computing coordinates using carrier phase and code signal from GNSS (Global Navigation Satellite System) satellites.
- Carrying out measurement tasks using various GNSS measuring techniques.
- Recording GNSS and point related data.
- Computation and evaluation by means of software.
- Data transfer via radio or digital cellular phone for real-time kinematic surveys.

Adverse use

- Use of the product without instruction.
- Use outside of the intended limits.
- Disabling safety systems.

- Removal of hazard notices.
- Opening the product using tools, for example screwdriver, unless this is specifically permitted for certain functions.
- Modification or conversion of the product.
- Use after misappropriation.
- Use of products with obviously recognizable damages or defects.
- Use with accessories from other manufacturers without the prior explicit approval of Leica Geosystems.
- Aiming directly into the sun.
- Inadequate safeguards at the surveying site, for example when measuring on roads.
- Deliberate dazzling of third parties.
- Controlling of machines, moving objects or similar monitoring application without additional control- and safety installations.



Adverse use can lead to injury, malfunction and damage.

It is the task of the person responsible for the equipment to inform the user about hazards and how to counteract them. The product is not to be operated until the user has been instructed on how to work with it.

6.3 Limits of Use

Environment

Suitable for use in an atmosphere appropriate for permanent human habitation: not suitable for use in aggressive or explosive environments.



Danger

Local safety authorities and safety experts must be contacted before working in hazardous areas, or in close proximity to electrical installations or similar situations by the person in charge of the product.

6.4 Responsibilities

Manufacturer of the product

Leica Geosystems AG, CH-9435 Heerbrugg, hereinafter referred to as Leica Geosystems, is responsible for supplying the product, including the user manual and original accessories, in a completely safe condition.

Manufacturers of non Leica Geosystems accessories

The manufacturers of non Leica Geosystems accessories for the product are responsible for developing, implementing and communicating safety concepts for their products, and are also responsible for the effectiveness of those safety concepts in combination with the Leica Geosystems product.

Person in charge of the product

The person in charge of the product has the following duties:

- To understand the safety instructions on the product and the instructions in the user manual.
- To be familiar with local regulations relating to safety and accident prevention.
- To inform Leica Geosystems immediately if the product and the application becomes unsafe.



The person responsible for the product must ensure that it is used in accordance with the instructions. This person is also accountable for the training and the deployment of personnel who use the product and for the safety of the equipment in use.

6.5 International Warranty, Software Licence Agreement

International Warranty

The International Warranty can be downloaded from the Leica Geosystems home page at <http://www.leica-geosystems.com/internationalwarranty> or received from your Leica Geosystems dealer.

Software Licence Agreement

This product contains software that is preinstalled on the product, or that is supplied to you on a data carrier medium, or that can be downloaded by you online pursuant to prior authorization from Leica Geosystems. Such software is protected by copyright and other laws and its use is defined and regulated by the Leica Geosystems Software Licence Agreement, which covers aspects such as, but not limited to, Scope of the Licence, Warranty, Intellectual Property Rights, Limitation of Liability, Exclusion of other Assurances, Governing Law and Place of Jurisdiction. Please make sure, that at any time you fully comply with the terms and conditions of the Leica Geosystems Software Licence Agreement.

Such agreement is provided together with all products and can also be found at the Leica Geosystems home page at <http://www.leica-geosystems.com/swlicense> or your Leica Geosystems dealer.

You must not install or use the software unless you have read and accepted the terms and conditions of the Leica Geosystems Software Licence Agreement. Instal-

lation or use of the software or any part thereof, is deemed to be an acceptance of all the terms and conditions of such licence agreement. If you do not agree to all or some of the terms of such licence agreement, you may not download, install or use the software and you must return the unused software together with its accompanying documentation and the purchase receipt to the dealer from whom you purchased the product within ten (10) days of purchase to obtain a full refund of the purchase price.

6.6 Hazards of Use

Warning

The absence of instruction, or the inadequate imparting of instruction, can lead to incorrect or adverse use, and can give rise to accidents with far-reaching human, material, financial and environmental consequences.

Precautions:

All users must follow the safety directions given by the manufacturer and the directions of the person responsible for the product.

Caution

Watch out for erroneous measurement results if the product has been dropped or has been misused, modified, stored for long periods or transported.

Precautions:

Periodically carry out test measurements and perform the field adjustments indicated in the user manual, particularly after the product has been subjected to abnormal use and before and after important measurements.

 **Danger**

Because of the risk of electrocution, it is very dangerous to use poles and extensions in the vicinity of electrical installations such as power cables or electrical railways.

Precautions:

Keep at a safe distance from electrical installations. If it is essential to work in this environment, first contact the safety authorities responsible for the electrical installations and follow their instructions.

 **Warning**

By surveying during a thunderstorm you are at risk from lightning.

Precautions:

Do not carry out field surveys during thunderstorms.

 **Caution**

Be careful when pointing the product towards the sun, because the telescope functions as a magnifying glass and can injure your eyes and/or cause damage inside the product.

Precautions:

Do not point the product directly at the sun.

 **Warning**

During dynamic applications, for example stakeout procedures there is a danger of accidents occurring if the user does not pay attention to the environmental conditions around, for example obstacles, excavations or traffic.

Precautions:

The person responsible for the product must make all users fully aware of the existing dangers.

 **Warning**

Inadequate securing of the surveying site can lead to dangerous situations, for example in traffic, on building sites, and at industrial installations.

Precautions:

Always ensure that the survey site is adequately secured. Adhere to the regulations governing safety and accident prevention and road traffic.

 **Warning**

Only Leica Geosystems authorized service workshops are entitled to repair these products.

 **Warning**

If computers intended for use indoors are used in the field there is a danger of electric shock.

Precautions:

Adhere to the instructions given by the computer manufacturer with regard to field use in conjunction with Leica Geosystems products.

 **Caution**

If the accessories used with the product are not properly secured and the product is subjected to mechanical shock, for example blows or falling, the product may be damaged or people may sustain injury.

Precautions:

When setting-up the product, make sure that the accessories, for example tripod, tribrach, connecting cables, are correctly adapted, fitted, secured, and locked in position.

Avoid subjecting the product to mechanical stress.

 **Caution**

During the transport, shipping or disposal of batteries it is possible for inappropriate mechanical influences to constitute a fire hazard.

Precautions:

Before shipping the product or disposing of it, discharge the batteries by running the product until they are flat.

When transporting or shipping batteries, the person in charge of the product must ensure that the applicable national and international rules and regulations are observed. Before transportation or shipping contact your local passenger or freight transport company.

 **Warning**

Using a battery charger not recommended by Leica Geosystems can destroy the batteries. This can cause fire or explosions.

Precautions:

Only use chargers recommended by Leica Geosystems to charge the batteries.

 **Warning**

High mechanical stress, high ambient temperatures or immersion into fluids can cause leakage, fire or explosions of the batteries.

Precautions:

Protect the batteries from mechanical influences and high ambient temperatures. Do not drop or immerse batteries into fluids.

 **Warning**

Short circuited battery terminals can overheat and cause injury or fire, for example by storing or transporting in pockets if battery terminals come in contact with jewellery, keys, metallized paper or other metals.

Precautions:

Make sure that the battery terminals do not come into contact with metallic objects.

 **Warning**

If the product is improperly disposed of, the following can happen:

- If polymer parts are burnt, poisonous gases are produced which may impair health.
- If batteries are damaged or are heated strongly, they can explode and cause poisoning, burning, corrosion or environmental contamination.

- By disposing of the product irresponsibly you may enable unauthorized persons to use it in contravention of the regulations, exposing themselves and third parties to the risk of severe injury and rendering the environment liable to contamination.
- Improper disposal of silicone oil may cause environmental contamination.

Precautions:

The product must not be disposed with household waste.

Dispose of the product appropriately in accordance with the national regulations in force in your country.

Always prevent access to the product by unauthorized personnel.

Product specific treatment and waste management information can be downloaded from the Leica Geosystems home page at <http://www.leica-geosystems.com/treatment> or received from your Leica Geosystems dealer.

 **Caution**

The product uses the GPS P-Code signal which by U.S. policy may be switched off without notice.

6.7 Laser Classification

6.7.1 Integrated Distancer, Measurements with Reflectors (IR mode)

General

	<p>The EDM module built into this product produces an invisible laser beam which emerges from the telescope objective.</p>
	<p>The product is a Class 1 Laser Product in accordance with:</p> <ul style="list-style-type: none">• IEC 60825-1 (2001-08): "Safety of Laser Products"• EN 60825-1:1994 + A11:1996 + A2:2001: "Safety of Laser Products"
	<p>Class 1 Laser Products are safe under reasonably foreseeable conditions of operation and are not harmful to the eyes provided that the products are used and maintained in accordance with the instructions.</p>
	<p>Maximum average radiant power 0.33 mW ± 5%</p>
	<p>Maximum peak radiant power 4.12 mW ± 5%</p>
	<p>Pulse duration 800 ps</p>
	<p>Pulse repetition frequency 100 MHz</p>
	<p>Beam divergence 1.5 mrad x 3 mrad TCA1201M: 0.6 mrad x 1.3 mrad</p>

	The EDM module built into this product produces a visible laser beam which emerges from the telescope objective.	
	The product is a Class 1 Laser Product in accordance with:	
	<ul style="list-style-type: none">• IEC 60825-1 (2001-08): "Safety of Laser Products"• EN 60825-1:1994 + A11:1996 + A2:2001: "Safety of Laser Products"	
	Class 1 Laser Products are safe under reasonably foreseeable conditions of operation and are not harmful to the eyes provided that the products are used and maintained in accordance with the instructions.	
	Maximum average radiant power	0.33 mW \pm 5%
	Maximum peak radiant power	4.12 mW \pm 5%
	Pulse duration	800 ps
	Pulse repetition frequency	100 MHz - 150 MHz
Beam divergence	1.5 mrad x 3 mrad	

Labelling

Type: TC.... **Art.No.:**

Power: 12V/6V ---, 1A max

Leica Geosystems AG

CH-9435 Heerbrugg

Manufactured: 2003

Made in Switzerland

 **S.No.:**

CE

Complies with 21 CFR 1040.10 and 1040.11 except for deviations pursuant to Laser Notice No.50, dated July 26,2001.

This device complies with part 15 of the FCC Rules. Operation is subject to the following two conditions: (1) This device may not cause harmful interference, and (2) this device must accept any interference received, including interference that may cause undesired operation.

Class 1 Laser Product

according to IEC 60825-1
(2001 - 08)

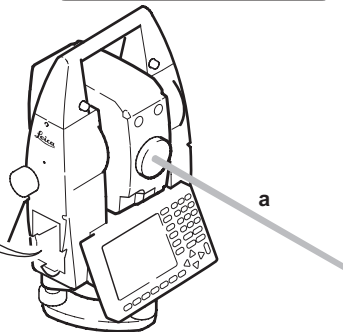

TPS12_044

a) Laser beam

6.7.2 Integrated Distancer, Measurements without Reflectors (RL mode)

General



As an alternative to the invisible laser, the EDM incorporated into the product produces a visible red laser beam which emerges from the telescope objective.

The products are Class 3R Laser Products in accordance with:

- IEC 60825-1 (2001-08): "Safety of Laser Products"
- EN 60825-1:1994 + A11:1996 + A2:2001: "Safety of Laser Products"

Class 3R Laser Products:

For safety aspects direct intrabeam viewing should always be considered as hazardous. Avoid direct eye exposure. The accessible emission limit is within five times the accessible emission limits of Class 2 in the wavelength range from 400 nm to 700 nm.

Description	R100	R300
Maximum average radiant power	4.75 mW \pm 5%	4.75 mW \pm 5%
Maximum peak radiant power	59 mW \pm 5%	59 mW \pm 5%
Pulse duration	800 ps	800 ps

Pulse repetition frequency	100 MHz	100 MHz - 150 MHz
Beam divergence	0.15 mrad x 0.35 mrad	0.15 mrad x 0.5 mrad

○	The EDM module built into the product produces a visible laser beam which emerges from the telescope objective.	
	The products are Class 3R Laser Products in accordance with:	
	<ul style="list-style-type: none"> • IEC 60825-1 (2001-08): "Safety of Laser Products" • EN 60825-1:1994 + A11:1996 + A2:2001: "Safety of Laser Products" 	
	Class 3R Laser Products:	
	For safety aspects direct intrabeam viewing should always be considered as hazardous. Avoid direct eye exposure. The accessible emission limit is within five times the accessible emission limits of Class 2 in the wavelength range from 400 nm to 700 nm.	
Description		Value
Maximum average radiant power		4.75 mW ± 5%
Maximum peak radiant power		59 mW ± 5%
Pulse duration		800 ps

Pulse repetition frequency	100 MHz - 150 MHz
Beam divergence	0.2 mrad x 0.3 mrad

 **Warning**

For safety aspects direct intrabeam viewing should always be considered as hazardous.

Precautions:

Do not stare into the beam or direct it towards other people unnecessarily. These measures are also valid for the reflected beam.

 **Warning**

Looking directly into the reflected laser beam could be dangerous to the eyes when the laser beam is aimed at areas that reflect like a mirror or emit reflections unexpectedly, for example prisms, mirrors, metallic surfaces or windows.

Precautions:

Do not aim at areas that are essentially reflective, such as a mirror, or which could emit unwanted reflections.

Do not look through or beside the optical sight at prisms or reflecting objects when the laser is switched on, in laserpointer or distance measurement mode. Aiming at prisms is only permitted when looking through the telescope.

 **Warning**

The use of Laser Class 3R equipment can be dangerous.

Precautions:

To counteract hazards, it is essential for every user to respect the safety precautions and control measures specified in the standard IEC 60825-1 (2001-08) resp. EN 60825-1:1994 + A11:1996 + A2:2001, within the hazard distance *); pay particular attention to Section Three "User's Guide".

Following an interpretation of the main points in the relevant section of the standard quoted.

Class 3R Laser Products used on construction sites and outdoors, for example surveying, alignment, levelling:

- a) Only qualified and trained persons should be assigned to install, adjust and operate the laser equipment.
- b) Areas in which these lasers are used should be posted with an appropriate laser warning sign.
- c) Precautions should be taken to ensure that persons do not look directly, with or without an optical instrument, into the beam.
- d) The laser beam should be terminated at the end of its useful beam path and should in all cases be terminated if the hazardous beam path extends beyond the limit (hazard distance *) of the area in which the presence and activities of personnel are monitored for reasons of protection from laser radiation.

- e) The laser beam path should be located well above or below eye level wherever practicable.
- f) When not in use the Laser Product should be stored in a location where unauthorized personnel cannot gain access.
- g) Precautions should be taken to ensure that the laser beam is not unintentionally directed at mirror-like, specular surfaces for example mirrors, metal surfaces or windows. But, more importantly, at flat or concave mirror-like surfaces.

- *) The hazard distance is the distance from the laser at which beam irradiance or radiant exposure equals the maximum permissible value to which personnel may be exposed without being exposed to a health risk.

For products with an integrated distancer of laser class 3R this hazard distance is 96 m / 315 ft. At this distance, the laser beam rates as Class 1M, that means direct intrabeam viewing is not hazardous.

Labelling

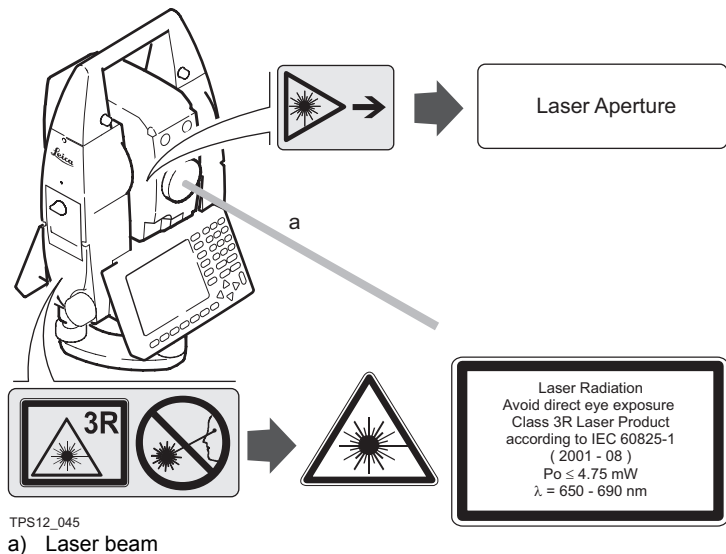

Type: TC.... **Art.No.:**

Power: 12V/6V $\overline{\text{---}}$, 1A max

Leica Geosystems AG

CH-9435 Heerbrugg

Manufactured: 2003

Made in Switzerland

 **S.No.:**

CE

Complies with 21 CFR 1040.10 and 1040.11 except for deviations pursuant to Laser Notice No.50, dated July 26,2001.

This device complies with part 15 of the FCC Rules. Operation is subject to the following two conditions: (1) This device may not cause harmful interference, and (2) this device must accept any interference received, including interference that may cause undesired operation.

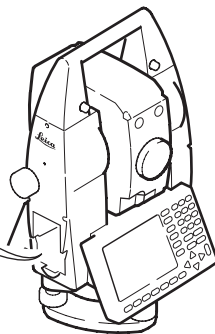

TPS12_065

6.7.3 Automatic Target Recognition ATR

General

The integrated automatic target recognition produces an invisible laser beam which emerges from the telescope objective.

The product is a Class 1 Laser Product in accordance with:

- IEC 60825-1 (2001-08): "Safety of Laser Products".
- EN 60825-1:1994 + A11:1996 + A2:2001: "Safety of Laser Products".

Class 1 Laser Products are safe under reasonably foreseeable conditions of operation and are not harmful to the eyes provided that the products are used and maintained in accordance with the instructions.

Description	Value
Maximum average radiant power	8 mW \pm 5%
Maximum peak radiant power	8 mW \pm 5%
Pulse duration	21.8 ms
Pulse repetition frequency	46 Hz
Beam divergence	1.4°

Labelling

Type: TC... **Art.No.:**

Power: 12V/6V \approx , 1A max

Leica Geosystems AG

CH-9435 Heerbrugg

Manufactured: 2003

Made in Switzerland

S.No.:

Complies with 21 CFR 1040.10 and 1040.11
except for deviations pursuant to Laser Notice
No.50, dated July 26,2001.

This device complies with part 15 of the FCC
Rules. Operation is subject to the following two
conditions: (1) This device may not cause harmful
interference, and (2) this device must accept
any interference received, including interference
that may cause undesired operation.

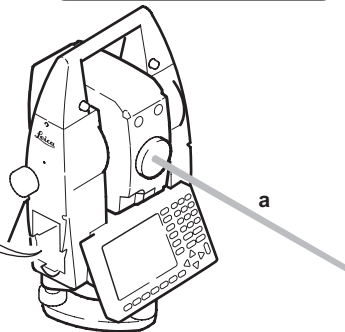
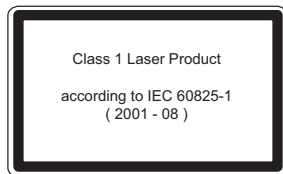

TPS12_044

a) Laser beam

6.7.4 PowerSearch PS

General

The integrated PowerSearch generates an invisible laser from the lower front side of the telescope.

The product is a Class 1 Laser Product in accordance with:

- IEC 60825-1 (2001-08): "Safety of Laser Products".
- EN 60825-1:1994 + A11:1996 + A2:2001: "Safety of Laser Products".

Class 1 Laser Products are safe under reasonably foreseeable conditions of operation and are not harmful to the eyes provided that the products are used and maintained in accordance with the instructions.

Description	Value
Maximum average radiant power	11 mW \pm 5%
Maximum peak radiant power	5.3 W, 0.66 W \pm 5%
Pulse duration	40 ns, 80 ns
Pulse repetition frequency	24.4 kHz
Beam divergence	0.4 mrad x 700 mrad

Labelling

Type: TC.... **Art.No.:**

Power: 12V/6V $\overline{=}$, 1A max

Leica Geosystems AG

CH-9435 Heerbrugg

Manufactured: 2003

Made in Switzerland

 S.No.:

Complies with 21 CFR 1040.10 and 1040.11
except for deviations pursuant to Laser Notice
No.50, dated July 26,2001.

This device complies with part 15 of the FCC
Rules. Operation is subject to the following two
conditions: (1) This device may not cause harm-
ful interference, and (2) this device must accept
any interference received, including inter-
ference that may cause undesired operation.

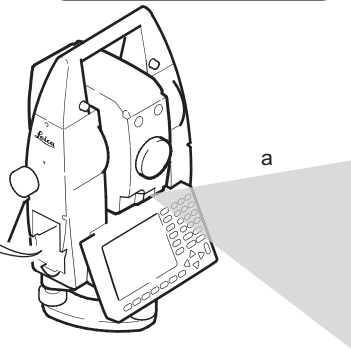
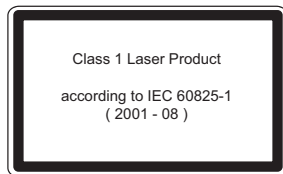

TPS12_046

a) Laser beam

6.7.5 Electronic Guide Light EGL

General

The integrated electronic guide light produces a visible LED beam from the front side of the telescope. Depending on the type of telescope the EGL may be designed differently.

The product is a Class 1 LED product in accordance with:

- IEC 60825-1 (2001-08): "Safety of Laser Products".
- EN 60825-1:1994 + A11:1996 + A2:2001: "Safety of Laser Products".

Class 1 LED products are safe under reasonably foreseeable conditions of operation and are not harmful to the eyes provided that the products are used and maintained in accordance with the instructions.

Flashing LED	Yellow	Red
Maximum average radiant power	0.28 mW \pm 5%	0.47 mW \pm 5%
Maximum peak radiant power	0.75 mW \pm 5%	2.5 mW \pm 5%
Pulse duration	2 x 105 ms	1 x 105 ms
Pulse repetition frequency	1.786 Hz	1.786 Hz
Beam divergence	2.4 °	2.4 °

Labelling

Type: TC.... **Art.No.:**

Power: 12V/6V ---, 1A max

Leica Geosystems AG

CH-9435 Heerbrugg

Manufactured: 2003

Made in Switzerland

 **S.No.:**

Complies with 21 CFR 1040.10 and 1040.11
except for deviations pursuant to Laser Notice
No.50, dated July 26,2001.

This device complies with part 15 of the FCC
Rules. Operation is subject to the following two
conditions: (1) This device may not cause harmful
interference, and (2) this device must accept
any interference received, including inter-
ference that may cause undesired operation.



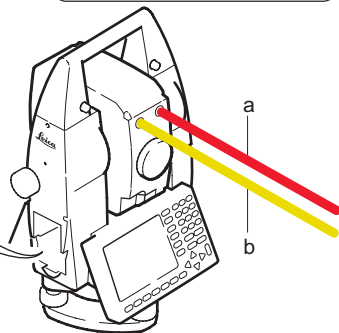
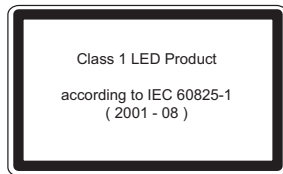

TPS12_064

- a) LED beam red
- b) LED beam yellow

6.7.6 Laser Plummet

General

The laser plummet built into the product produces a visible red laser beam which emerges from the bottom of the product.

The product is a Class 2 Laser Product in accordance with:

- IEC 60825-1 (2001-08): "Safety of Laser Products".
- EN 60825-1:1994 + A11:1996 + A2:2001: "Safety of Laser Products".

Class 2 Laser Products:

Do not stare into the beam or direct it unnecessarily at other persons. Eye protection is normally afforded by aversion responses including the blink reflex.

Description	Value
Maximum average radiant power	0.95 mW \pm 5%
Pulse duration	c.w.
Beam divergence	0.16 mrad x 0.6 mrad

**Warning**

It can be dangerous to look into the beam with optical equipment, for example binoculars or telescopes.

Precautions:

Do not look directly into the beam with optical equipment.

Labelling

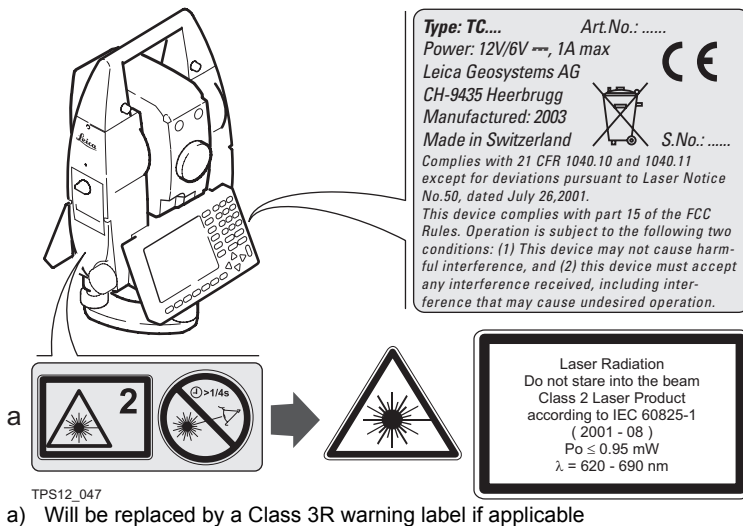

The diagram illustrates the labelling requirements for the Leica TPS1200 total station. It features a line drawing of the instrument with a callout box containing technical specifications and regulatory information. Below the instrument, a diagram shows the replacement of a Class 2 laser warning label with a Class 3R label, accompanied by a laser radiation warning label and its corresponding text.

Type: TC.... **Art.No.:**

Power: 12V/6V ---, 1A max

Leica Geosystems AG

CH-9435 Heerbrugg

Manufactured: 2003

Made in Switzerland

S.No.:

Complies with 21 CFR 1040.10 and 1040.11 except for deviations pursuant to Laser Notice No.50, dated July 26,2001.

This device complies with part 15 of the FCC Rules. Operation is subject to the following two conditions: (1) This device may not cause harmful interference, and (2) this device must accept any interference received, including interference that may cause undesired operation.

Laser Radiation
Do not stare into the beam
Class 2 Laser Product
according to IEC 60825-1
(2001 - 08)
 $P_o \leq 0.95 \text{ mW}$
 $\lambda = 620 - 690 \text{ nm}$

a) Will be replaced by a Class 3R warning label if applicable

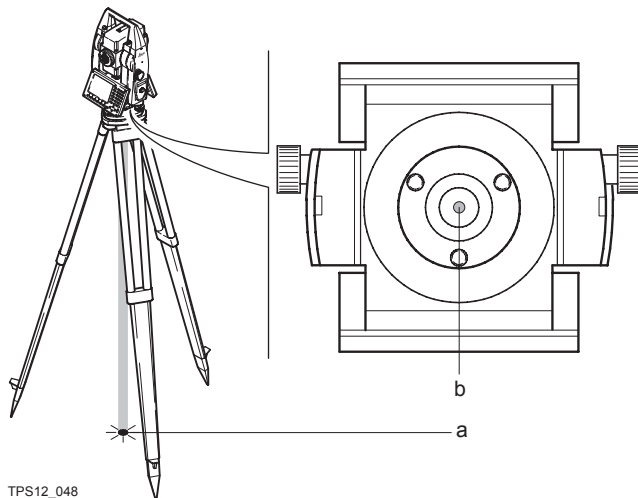

TPS12_048

- a) Laser beam
- b) Exit for laser beam

6.8 Electromagnetic Compatibility EMC

Description

The term Electromagnetic Compatibility is taken to mean the capability of the product to function smoothly in an environment where electromagnetic radiation and electrostatic discharges are present, and without causing electromagnetic disturbances to other equipment.



Warning

Electromagnetic radiation can cause disturbances in other equipment.

Although the product meets the strict regulations and standards which are in force in this respect, Leica Geosystems cannot completely exclude the possibility that other equipment may be disturbed.



Caution

There is a risk that disturbances may be caused in other equipment if the product is used in conjunction with accessories from other manufacturers, for example field computers, personal computers, two-way radios, non-standard cables or external batteries.

Precautions:

Use only the equipment and accessories recommended by Leica Geosystems. When combined with the product, they meet the strict requirements stipulated by the guidelines and standards. When using computers and two-way radios, pay attention to the information about electromagnetic compatibility provided by the manufacturer.

 **Caution**

Disturbances caused by electromagnetic radiation can result in erroneous measurements.

Although the product meets the strict regulations and standards which are in force in this respect, Leica Geosystems cannot completely exclude the possibility that the product may be disturbed by very intense electromagnetic radiation, for example, near radio transmitters, two-way radios or diesel generators.

Precautions:

Check the plausibility of results obtained under these conditions.

 **Warning**

If the product is operated with connecting cables attached at only one of their two ends, for example external supply cables, interface cables, the permitted level of electromagnetic radiation may be exceeded and the correct functioning of other products may be impaired.

Precautions:

While the product is in use, connecting cables, for example product to external battery, product to computer, must be connected at both ends.

**Radios, digital
cellular phones or
SmartAntenna with
Bluetooth**



Use of product with radio, digital cellular phone devices or SmartAntenna with Bluetooth:

Electromagnetic radiation can cause disturbances in other equipment, in installations, in medical devices, for example pacemakers or hearing aids and in aircraft. It can also affect humans and animals.

Precautions:

Although the product meets in combination with radio or digital cellular phone devices recommended by Leica Geosystems the strict regulations and standards which are in force in this respect, Leica Geosystems cannot completely exclude the possibility that other equipment may be disturbed or that humans or animals may be affected.

- Do not operate the product with radio or digital cellular phone devices in the vicinity of filling stations or chemical installations, or in other areas where an explosion hazard exists.
- Do not operate the product with radio or digital cellular phone devices near to medical equipment.
- Do not operate the product with radio or digital cellular phone devices in aircraft.
- Do not operate the product with radio or digital cellular phone devices for long periods immediately next to your body.

6.9 FCC Statement, Applicable in U.S.

Applicability

The greyed paragraph below is only applicable for products of the TPS1200 System without radio, digital cellular phone devices or Bluetooth.

Warning

This equipment has been tested and found to comply with the limits for a Class B digital device, pursuant to part 15 of the FCC rules.

These limits are designed to provide reasonable protection against harmful interference in a residential installation.

This equipment generates, uses and can radiate radio frequency energy and, if not installed and used in accordance with the instructions, may cause harmful interference to radio communications. However, there is no guarantee that interference will not occur in a particular installation.

If this equipment does cause harmful interference to radio or television reception, which can be determined by turning the equipment off and on, the user is encouraged to try to correct the interference by one or more of the following measures:

- Reorient or relocate the receiving antenna.
- Increase the separation between the equipment and the receiver.
- Connect the equipment into an outlet on a circuit different from that to which the receiver is connected.
- Consult the dealer or an experienced radio/TV technician for help.

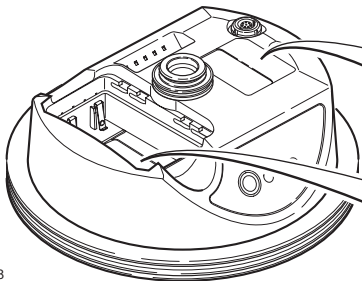
**Labelling
SmartAntenna**

This device complies with part 15 of the FCC Rules. Operation is subject to the following two conditions: (1) This device may not cause harmful interference, and (2) this device must accept any interference received, including interference that may cause undesired operation.

Type: AT... Art.No.:
Equip.No.: XXXXXX S.No.:
Power: 12V $\overline{-}$, nominal 1/0.5A max.
Leica Geosystems AG
CH-9435 Heerbrugg
Manufactured: 2004
Made in Switzerland S.No.:



TPS12_208

**Labelling
clip-on-housings
GFU19, GFU25**

Type: GFUXX

.....

.....

.....

.....

.....

.....



This device complies with part 15 of the FCC Rules. Operation is subject to the following two conditions: (1) This device may not cause harmful interference, and (2) this device must accept any interference received, including interference that may cause undesired operation.

TPS12_218

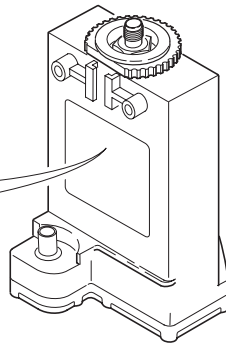

**Labelling
internal battery
GEB211, GEB221**

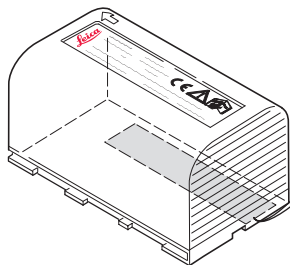

This device complies with part 15 of the FCC Rules. Operation is subject to the following two conditions: (1) This device may not cause harmful interference, and (2) this device must accept any interference received, including interference that may cause undesired operation.



TPS12_082

Labelling RadioHandle

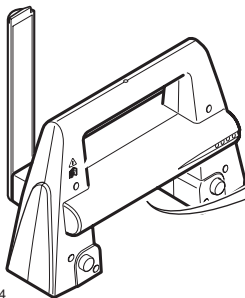

TPS12_214

Type: RH....

Art.No.:

Power: 7.4/12V^{max}, nominal 0.2A max.
100mW EIRP

Leica Geosystems AG

CH-9435 Heerbrugg

Manufactured: 2004

Made in Switzerland

This device contains
a transmitter:

FCC ID: HSW-2410M

S.No.: XXXXXX



This device complies with part 15 of the FCC Rules. Operation is subject to the following two conditions: (1) This device may not cause harmful interference, and (2) this device must accept any interference received, including interference that may cause undesired operation.

7 Technical Data

7.1 Angle Measurement

Accuracy

Type	Standard deviation Hz, V, ISO 17123-3		Display least count	
	["]	[mgon]	["]	[mgon]
1201	1	0.3	0.1	0.1
1202	2	0.6	0.1	0.1
1203	3	1.0	0.1	0.5
1205	5	1.5	0.1	0.5

Characteristics

Absolute, continuous, diametric.

Atmospheric conditions

- A: Strong haze, visibility 5 km; or strong sunlight, severe heat shimmer
B: Light haze, visibility about 20 km; or moderate sunlight, slight heat shimmer
C: Overcast, no haze, visibility about 40 km; no heat shimmer



Measurements can be made to reflector tapes over the entire range without external ancillary optics.

Accuracy

Accuracy refers to measurements to standard prisms.

EDM measuring program	Standard deviation, ISO 17123-4, standard prism	Standard deviation, ISO 17123-4, tape	Measurement time, typical [s]
Standard	2 mm + 2 ppm	5 mm + 2 ppm	1.5
Fast	5 mm + 2 ppm	5 mm + 2 ppm	0.8
Tracking	5 mm + 2 ppm	5 mm + 2 ppm	< 0.15
Averaging	2 mm + 2 ppm	5 mm + 2 ppm	-

Beam interruptions, severe heat shimmer and moving objects within the beam path can result in deviations of the specified accuracy.

The display resolution is 0.1 mm.

Characteristics



Principle: Phase measurement
Type: Coaxial, infrared laser Class 1
Carrier wave: 780 nm
Measuring system: Special frequency system basis 100 MHz \pm 1.5 m



Principle: Phase measurement
Type: Coaxial, visible red laser Class 1
Carrier wave: 660 nm
Measuring system: System analyser basis 100 MHz - 150 MHz

7.3 Distance Measurement without Reflectors (RL mode)

Range

Type	Kodak Gray Card	Range D		Range E		Range F	
		[m]	[ft]	[m]	[ft]	[m]	[ft]
R100	White side, 90 % reflective	140	460	170	560	>170	>560
R100	Grey side, 18 % reflective	70	230	100	330	>100	>330
R300	White side, 90 % reflective	300	990	500	1640	>500	>1640
R300	Grey side, 18 % reflective	200	660	300	990	>300	>990

Range of measurement:

1.5 m to 760 m

Display unambiguous:

Up to 760 m

Atmospheric conditions

D: Object in strong sunlight, severe heat shimmer

E: Object in shade, sky overcast

F: Underground, night and twilight

Accuracy

Standard measuring	Standard deviation, ISO 17123-4	Measure time, typical [s]	Measure time, maximum [s]
Reflectorless 1.5 m - 500 m	3 mm + 2 ppm	3 - 6	12
Reflectorless >500 m	5 mm + 2 ppm	3 - 6	12

Object in shade, sky overcast.

Beam interruptions, severe heat shimmer and moving objects within the beam path can result in deviations of the specified accuracy.

The display resolution is 0.1 mm.

Characteristics



Measuring system R100: Special frequency system basis 100 MHz \cong 1.5 m

Measuring system R300: System analyser basis 100 MHz - 150 MHz

Type: Coaxial, visible red laser Class 3R

Carrier wave: 670 nm



Measuring system: System analyser basis 100 MHz - 150 MHz

Type: Coaxial, visible red laser Class 3R

Carrier wave: 660 nm

Laser dot size

Distance [m]	Laser dot size, approximately [mm]
at 20	7 x 14
at 100	12 x 40
at 200	25 x 80
at 300	36 x 120
at 400	48 x 160
at 500	60 x 200

7.4 Distance Measurement - Long Range (LO mode)

Range

The range of the long range measurements is the same for R100 and R300.

Reflector	Range A		Range B		Range C	
	[m]	[ft]	[m]	[ft]	[m]	[ft]
Standard prism	2200	7300	7500	24600	>10000	>32800

Range of measurement to prism:

From 1000 m up

Display unambiguous:

Up to 12000 m

Atmospheric conditions

A: Strong haze, visibility 5 km; or strong sunlight, severe heat shimmer

B: Light haze, visibility about 20 km; or moderate sunlight, slight heat shimmer

C: Overcast, no haze, visibility about 40 km; no heat shimmer

Accuracy

Standard measuring	Standard deviation, ISO 17123-4	Measure time, typical [s]	Measure time, maximum [s]
Long Range	5 mm + 2 ppm	2.5	12

Beam interruptions, severe heat shimmer and moving objects within the beam path can result in deviations of the specified accuracy.

The display resolution is 0.1 mm.

Characteristics

Principle: Phase measurement
Type: Coaxial, visible red laser Class 3R
Carrier wave: 670 nm



Principle: Phase measurement
Type: Coaxial, visible red laser Class 3R
Carrier wave: 660 nm

7.5 Automatic Target Recognition ATR

Range ATR/LOCK

Reflector	Range ATR mode		Range Lock mode ²⁾	
	[m]	[ft]	[m]	[ft]
Standard prism	1000	3300	800	2600
360° prism	600	2000	500	1600
360° Mini prism	350	1150	300	1000
Mini prism	500	1600	400	1300
Reflector tape 60 mm x 60 mm	55	175	not qualified	

²⁾ Activating and working in lock mode is not recommended for the TCA1201M instrument, an automated total station for long range distance monitoring.

Shortest measuring distance

360° prism ATR: 1.5 m
360° prism LOCK: 5 m

Accuracy

- The accuracy with which the position of a prism can be determined with Automatic Target Recognition (ATR) depends on several factors such as internal ATR accuracy, instrument angle accuracy, prism type, selected EDM measuring program and the external measuring conditions. The ATR has a basic standard deviation level of ± 2 mm. Above a certain distance, the instrument angle accuracy predominates and takes over the standard deviation of the ATR.
- The following graph shows the ATR standard deviation based on two different prism types, distances and instrument accuracies.

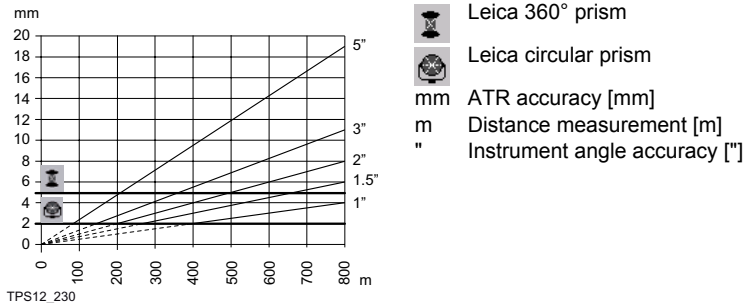

Maximum speed LOCK mode	Maximum tangential speed:	5 m/s at 20 m; 25 m/s at 100 m
	Maximum radial speed with <EDM Mode: Tracking> :	4 m/s
Searching	Typical search time in field of view:	3 s
	Field of view:	1°30'/1.66 gon
	Definable search windows:	Yes
Characteristics	Principle:	Digital image processing
	Type:	Infrared laser class 1

7.6 PowerSearch PS

Range

Reflector	Range PS	
	[m]	[ft]
Standard prism	200	650
360° prism	200*	650*
Mini prism	100	330

Measurements at the vertical limits of the fan or under unfavourable atmospheric conditions may reduce the maximum range. (*aligned to the instrument optimal)

Shortest measure distance

360° prism: 5 m

Searching

Typical search time: <10 s
Default search area: Hz: 400 gon, V: 40 gon
Definable search windows: Yes

Characteristics

Principle: Digital signal processing
Type: Infrared laser class 1

RTK data formats

Formats for data reception: Leica proprietary format,
CMR, CMR+, RTCM V2.1 / 2.2 / 2.3 / 3.0

7.7.2 SmartStation Dimensions

SmartStation Dimensions

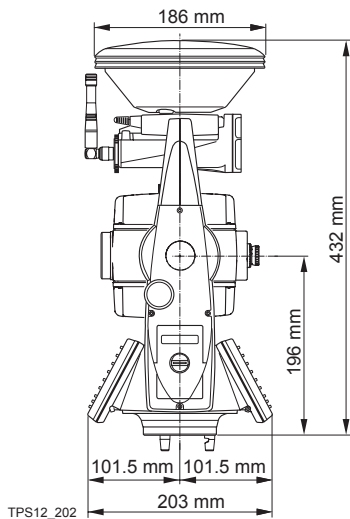

7.7.3 SmartAntenna Technical Data

Description and use

The SmartAntenna is selected for use based upon the application. The table gives a description and the intended use of the SmartAntenna.

Type	Description	Use
ATX1230 GG	L1/L2 SmartTrack+ antenna with built in groundplane.	With RX1250 or TPS1200.

Dimensions

Height: 0.089 m
Diameter: 0.186 m

Connector

- 8 pin LEMO-1 socket to connect antenna cable (only applicable when SmartAntenna is used independently on a pole with RX1250).
- Special clip-on interface for connecting SmartAntenna to SmartAntenna Adapter on a TPS1200 instrument.

Mounting

5/8" Whitworth

Weight

1.1 kg including internal battery GEB211

Power Power consumption: 1.8 W typically, 270 mA
External supply voltage: Nominal 12 V DC (---), voltage range 5-28 V DC

Battery internal Type: Li-Ion
Voltage: 7.4 V
Capacity: GEB211: 1.9 Ah
Typical operating time: 5 h

Electrical data

Type	ATX1230 GG
Voltage	-
Current	-
Frequency	GPS L1 1575.42 MHz GPS L2 1227.60 MHz GLONASS L1 1602.5625-1611.5 MHz GLONASS L2 1246.4375-1254.3 MHz
Gain	Typically 27 dBi
Noise Figure	Typically < 2 dBi
BW, -3 dBiW	-

Type	ATX1230 GG
BW, -30 dBi	-

Environmental specifications**Temperature**

Operating temperature [°C]	Storage temperature [°C]
-40 to +65	-40 to +80
Bluetooth: -30 to +65	

Protection against water, dust and sand

Protection
IP67 (IEC 60529)
Dusttight
Protected against water jets
Waterproof to 1 m temporary immersion

Humidity

Protection
Up to 100 % The effects of condensation are to be effectively counteracted by periodically drying out the antenna.

7.8 Conformity to National Regulations

7.8.1 Communication side cover with Bluetooth

Conformity to national regulations

- FCC Part 15 (applicable in US)
- Hereby, Leica Geosystems AG, declares that the Communication side cover with Bluetooth is in compliance with the essential requirements and other relevant provisions of Directive 1999/5/EC. The declaration of conformity may be consulted at <http://www.leica-geosystems.com/ce>.



Class 1 equipment according European Directive 1999/5/EC (R&TTE) can be placed on the market and be put into service without restrictions in any EU Member state.

- The conformity for countries with other national regulations not covered by the FCC part 15 or European directive 1999/5/EC has to be approved prior to use and operation.

Frequency band

2402 - 2480 MHz

Output power

Bluetooth: 5 mW

Antenna

Type Internal Microstrip antenna
Gain 1.5 dBi

7.8.2 GFU24, Siemens MC75

Conformity to national regulations

- FCC Part 15, 22 and 24 (applicable in US)
- Hereby, Leica Geosystems AG, declares that the GFU24 is in compliance with the essential requirements and other relevant provisions of Directive 1999/5/EC. The declaration of conformity may be consulted at <http://www.leica-geosystems.com/ce>.



Class 1 equipment according European Directive 1999/5/EC (R&TTE) can be placed on the market and be put into service without restrictions in any EU Member state.

- The conformity for countries with other national regulations not covered by the FCC part 15, 22 and 24 or European directive 1999/5/EC has to be approved prior to use and operation.

Frequency band

Quad-Band EGSM850 / EGSM900 / GSM1800 / GSM1900 MHz

Output power

EGSM850: 2 W
EGSM900: 2 W
GSM1800: 1 W
GSM1900: 1 W

Antennas

Type	GAT 3	GAT 5
Frequency band	900 or 1800 MHz	850 or 1900 MHz
Type	Detachable $\lambda/2$ antenna	Detachable $\lambda/2$ antenna
Gain	0 dBi	0 dBi
Connector	TNC	TNC

Specific Absorption Rate (SAR)

The product meets the limits for the maximum permissible exposure of the guidelines and standards which are force in this respect. The product must be used with the recommended antenna. A separation distance of at least 20 centimeters should be kept between the antenna and the body of the user or nearby person within the intended application.

7.8.3 GFU19 (US), GFU25 (CAN) CDMA MultiTech MTMMC-C

Conformity to National Regulations

- FCC Part 15, 22 and 24 (applicable in US).
- European Directive 1999/5/EC on radio equipment and telecommunication terminal equipment (see CE Conformity Declaration).
- The conformity for countries with other national regulations not covered by the FCC part 15, 22 and 24 or European directive 1999/5/EC has to be approved prior to use and operation.

Frequency band

Dual-Band CDMA850 / CDMA1900 MHz

Output power

CDMA850: 2 W
CDMA1900: 0.4 W

Antenna

Type	GAT 1204
Frequency band	850 / 1900 MHz
Type	Detachable $\lambda/4$ antenna
Gain	0 dBi
Connector	TNC

**Specific
Absorption Rate
(SAR)**

The product meets the limits for the maximum permissible exposure of the guidelines and standards which are force in this respect. The product must be used with the recommended antenna. A separation distance of at least 20 centimeters should be kept between the antenna and the body of the user or nearby person within the intended application.

7.8.4 RadioHandle

Conformity to national regulations

- FCC Part 15 (applicable in US)
- Hereby, Leica Geosystems AG, declares that the RadioHandle is in compliance with the essential requirements and other relevant provisions of Directive 1999/5/EC. The declaration of conformity may be consulted at <http://www.leica-geosystems.com/ce>.



Class 2 equipment according European Directive 1999/5/EC (R&TTE) for which following EEA Member States apply restrictions on the placing on the market or on the putting into service or require authorization for use:

- France
 - Italy
 - Norway (if used in the geographical area within a radius of 20km from the centre of Ny-Ålesund)
- The conformity for countries with other national regulations not covered by the FCC part 15 or European directive 1999/5/EC has to be approved prior to use and operation.

Frequency band

Limited to 2409 - 2435 MHz

Output power

< 100 mW (e. i. r. p.)

Antenna

Type:	Patch antenna (omnidirectional)
Gain:	2 dBi
Connector:	SMB

7.8.5 SmartAntenna with Bluetooth

Conformity to national regulations

- FCC Part 15 (applicable in US)
- Hereby, Leica Geosystems AG, declares that the SmartAntenna with Bluetooth is in compliance with the essential requirements and other relevant provisions of Directive 1999/5/EC. The declaration of conformity may be consulted at <http://www.leica-geosystems.com/ce>.



Class 1 equipment according European Directive 1999/5/EC (R&TTE) can be placed on the market and be put into service without restrictions in any EU Member state.

- The conformity for countries with other national regulations not covered by the FCC part 15 or European directive 1999/5/EC has to be approved prior to use and operation.

Frequency band

Type	Frequency band [MHz]
ATX1230 GG	1227.60 1575.42
ATX1230 GG	1246.4375 - 1254.3 1602.4375 - 1611.5
Bluetooth	2402 - 2480

Output power

Type	Output power [mW]
GNSS	Receive only
Bluetooth	5

Antenna

GNSS	Internal GNSS antenna element (receive only)
Bluetooth	Type: Internal Microstrip antenna Gain: 1.5 dBi

7.9 General Technical Data of the Instrument

Telescope

Magnification:	30 x
Clear objective diameter:	40 mm
Focusing:	1.7 m/5.6 ft to infinity
Field of view:	1°30'/1.66 gon
	2.7 m at 100 m

Compensator

Type	Setting accuracy		Setting range	
	["]	[mgon]	[']	[gon]
1201	0.5	0.2	4	0.07
1202	0.5	0.2	4	0.07
1203	1	0.3	4	0.07
1205	1.5	0.5	4	0.07

Level

Circular level sensitivity:	6'/2 mm
Electronic level resolution:	2"

Control unit	Display:	1/4 VGA (320 x 240 pixels), monochrome, graphics capable LCD, illumination, optional touch screen
	Keyboard:	34 keys including 12 function keys and 12 alphanumeric keys, illumination
	Angle Display:	360° ^m , 360° decimal, 400 gon, 6400 mil, V %
	Distance Display:	m, ft int, ft us, ft int inch, ft us inch
	Position:	In both faces, face two is optional
	Touch screen if fitted:	Toughened film on glass

Instrument Ports

Port	Name	Description
Port 1	Port 1	<ul style="list-style-type: none">5 pin LEMO-0 for power, communication, data transfer.This port is located at the base of the instrument.
Port 2	Handle	<ul style="list-style-type: none">Hotshoe connection for RadioHandle with RCS and SmartAntenna Adapter with SmartStation.This port is located on top of Communication side cover.
Port 3	BT	<ul style="list-style-type: none">Bluetooth module for communication.This port is housed within Communication side cover.

Instrument Dimensions

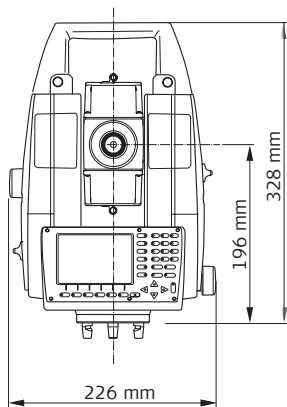

TPS12_212

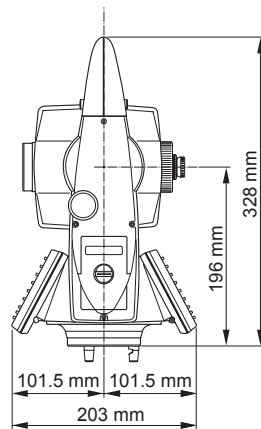

TPS12_213

Weight

Instrument:	4.8 - 5.5 kg
Tribrach:	0.8 kg
Internal battery GEB221:	0.2 kg

Recording

Data can be recorded onto a CompactFlash card or into internal memory if fitted.

Type	Capacity [MB]	Number of measurements per MB
CompactFlash card	<ul style="list-style-type: none">• 64• 256	1750
Internal memory - optional	<ul style="list-style-type: none">• 64	1750

Laser plummet

Type: Visible red laser class 2
Location: In standing axis of instrument
Accuracy: Deviation from plumbline:
1.5 mm at 1.5 m instrument height
Diameter of laser point: 2.5 mm at 1.5 m instrument height

Drives

Type: Endless horizontal and vertical drives

Motorisation

Maximum rotating speed: 50 gon/s

Power

External supply voltage: Nominal voltage 12.8 V DC, Range 11.5 V-13.5 V

Internal battery

Type:	Li-Ion
Voltage:	7.4 V
Capacity:	GEB221: 3.8 Ah
Typical operating time:	6 - 8 h

External battery

Type:	NiMH
Voltage:	12 V
Capacity:	GEB171: 8.0 Ah
Typical operating time:	20 - 24 h

Environmental specifications**Temperature**

Type	Operating temperature [°C]	Storage temperature [°C]
TPS1200	-20 to +50	-40 to +70
Leica CompactFlash cards, all sizes	-40 to +80	-40 to +80
Battery internal	-20 to +55	-40 to +70
Bluetooth	-30 to +60	-40 to +80

Protection against water, dust and sand

Type	Protection
TPS1200	IP54 (IEC 60529)

Humidity

Type	Protection
TPS1200	Max 95 % non condensing The effects of condensation are to be effectively counteracted by periodically drying out the instrument.

Reflectors

Type	Additive Constant [mm]	ATR	PS
Standard prism, GPR1	0.0	yes	yes
Mini prism, GMP101	+17.5	yes	yes
360° prism, GRZ4 / GRZ122	+23.1	yes	yes

Type	Additive Constant [mm]	ATR	PS
360° Mini prism, GRZ121	+30.0	yes	not recommended
Reflector tape S, M, L	+34.4	yes	no
Reflectorless	+34.4	no	no

There are no special prisms required for ATR or for PS.

Electronic Guide Light EGL

Working range: 5 - 150 m
Positioning accuracy: 5 cm at 100 m

Automatic corrections

The following automatic corrections are made:

- Line of sight error
- Tilting axis error
- Earth curvature
- Circle eccentricity
- Compensator index error
- Vertical index error
- Standing axis tilt
- Refraction
- ATR zero point error

7.10 Scale Correction

Use	<p>By entering a scale correction, reductions proportional to distance can be taken into account.</p> <ul style="list-style-type: none">• Atmospheric correction• Reduction to mean sea level• Projection distortion
Atmospheric correction ΔD_1	<hr/> <p>The slope distance displayed is correct if the scale correction in ppm, mm/km, which has been entered corresponds to the atmospheric conditions prevailing at the time of the measurement.</p> <p>The atmospheric correction includes:</p> <ul style="list-style-type: none">• Adjustments for air pressure• Air temperature• Relative humidity <p>For highest precision distance measurements, the atmospheric correction should be determined with an accuracy of 1 ppm. The following parameters must be redetermined:</p> <ul style="list-style-type: none">• Air temperature to 1°C

- Air pressure to 3 mbar
- Relative humidity to 20 %

Air humidity

The air humidity influences the distance measurement if the climate is extremely hot and damp.

For high precision measurements, the relative humidity must be measured and entered along with the air pressure and the temperature.

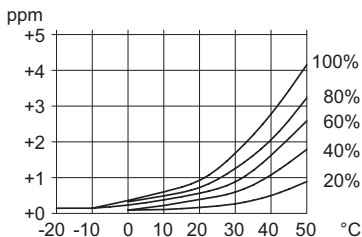

Air humidity correction



TPS12_050

ppm Air humidity correction [mm/km]
 % Relative humidity [%]
 C° Air temperature [°C]

Index n

	Type	Index n	carrier wave [nm]
	infrared EDM	1.0002830	780
	visible red laser	1.0002859	670
	combined EDM	1.0002863	660

The index n is calculated from the formula of Barrel and Sears, and is valid for:

Air pressure p: 1013.25 mbar

Air temperature t: 12 °C

Relative air humidity h: 60 %

Formulas

	Formula for infrared EDM
	$\Delta D_1 = 283.05 - \left[\frac{0.29196 \cdot p}{(1 + \alpha \cdot t)} - \frac{4.126 \cdot 10^{-4} \cdot h}{(1 + \alpha \cdot t)} \cdot 10^x \right]$ <p>TPS12_051</p>
	Formula for visible red laser

	$\Delta D_1 = 285.93 - \left[\frac{0.29493 \cdot p}{(1 + \alpha \cdot t)} - \frac{4.126 \cdot 10^{-4} \cdot h}{(1 + \alpha \cdot t)} \cdot 10^x \right]$ TPS12_052
	Formula for visible red laser $\Delta D_1 = 286.269 - \left[\frac{0.29528 \cdot p}{(1 + \alpha \cdot t)} - \frac{4.126 \cdot 10^{-4} \cdot h}{(1 + \alpha \cdot t)} \cdot 10^x \right]$ TPS12_229

ΔD_1 Atmospheric correction [ppm]

p Air pressure [mbar]

t Air temperature [°C]

h Relative humidity [%]

$$\alpha = \frac{1}{273.15}$$

$$x = (7.5 \cdot t / (237.3 + t)) + 0.7857$$

If the basic value of 60 % relative humidity as used by the EDM is retained, the maximum possible error in the calculated atmospheric correction is 2 ppm, 2 mm/km.

Reduction to mean sea level ΔD_2

The values for ΔD_2 are always negative and are derived from the following formula:

$$\Delta D_2 = -\frac{H}{R} \cdot 10^6$$

TPS12_053

ΔD_2 Reduction to mean sea level [ppm]

H Height of EDM above sea level [m]

R $6.378 \cdot 10^6$ m

Projection distortion ΔD_3

The magnitude of the projection distortion is in accordance with the projection system used in a particular country, for which official tables are generally available. The following formula is valid for cylindrical projections such as that of Gauss-Krüger:

$$\Delta D_3 = \frac{X^2}{2R^2} \cdot 10^6$$

TPS12_054

ΔD_3 Projection distortion [ppm]

X Northing, distance from projection zero line with the scale factor 1 [km]

R $6.378 \cdot 10^6$ m

In countries where the scale factor is not unity, this formula cannot be directly applied.

Atmospheric corrections °C

Atmospheric corrections in ppm with temperature [°C], air pressure [mb] and height [m] at 60 % relative humidity.

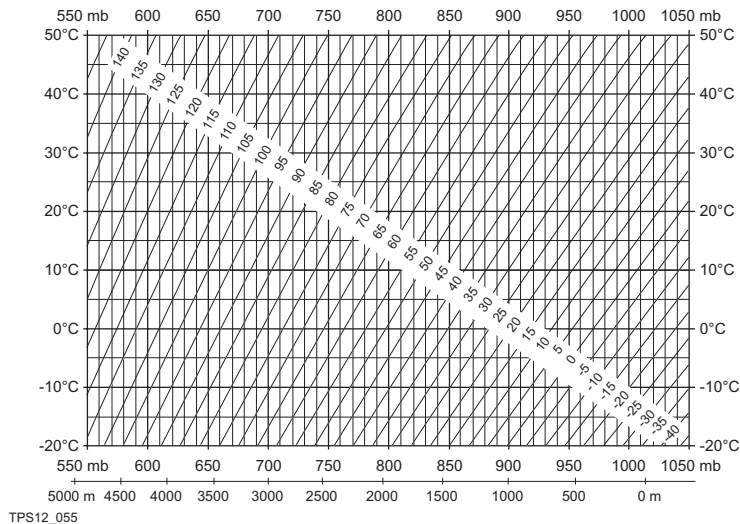

Atmospheric correction F

Atmospheric correction in ppm with temperature [F], air pressure [inch Hg] and height [ft] at 60 % relative humidity.

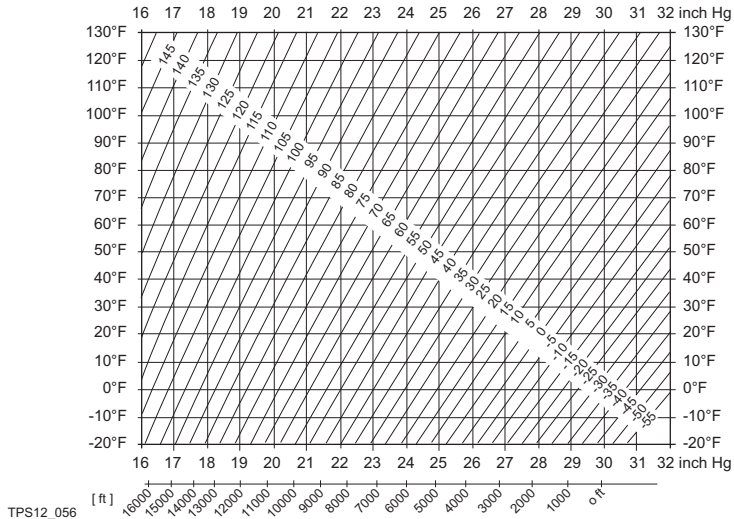

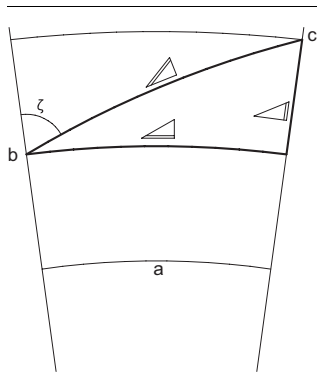

7.11 Reduction Formulas

Height
measurement



TPS12_057

- a) Mean Sea Level
- b) Instrument
- c) Reflector
-  Slope distance
-  Horizontal distance
-  Height difference

Formula

The instrument calculates in accordance with the following formula:

- slope distance
- horizontal distance
- height difference

Earth curvature and mean refraction coefficient $k = 0.13$ are taken into account automatically. The calculated horizontal distance relates to the station height, not to the reflector height.

$$\sphericalangle = D_0 \cdot (1 + \text{ppm} \cdot 10^{-6}) + \text{mm}$$

TPS12_058

- \sphericalangle Displayed slope distance [m]
- D_0 Uncorrected distance [m]
- ppm Scale correction [mm/km]
- mm Additive constant, prism [mm]

$$\sphericalangle = Y - A \cdot X \cdot Y$$

TPS12_059

$$\sphericalangle = X + B \cdot Y^2$$

TPS12_060

- \sphericalangle Horizontal distance [m]
- \sphericalangle Height difference [m]
- Y $\sphericalangle \cdot |\sin\zeta|$
- X $\sphericalangle \cdot \cos\zeta$
- ζ Vertical circle reading
- A $(1 - k/2)/R = 1.47 \cdot 10^{-7} \text{ [m}^{-1}\text{]}$
- B $(1 - k)/2R = 6.83 \cdot 10^{-8} \text{ [m}^{-1}\text{]}$
- k 0.13
- R $6.378 \cdot 10^6 \text{ m}$

**Distance
measuring
program Averaging**

In the distance measuring program Averaging, the following values are displayed:

- D Slope distance as arithmetic mean of all measurements
- s Standard deviation of a single measurement
- n Number of measurements

These values are calculated as follows:

$$\bar{D} = \frac{1}{n} \cdot \sum_{i=1}^n D_i$$

TPS12_061

$$s = \sqrt{\frac{\sum_{i=1}^n (D_i - \bar{D})^2}{n - 1}} = \sqrt{\frac{\sum_{i=1}^n D_i^2 - \frac{1}{n} \left(\sum_{i=1}^n D_i \right)^2}{n - 1}}$$

TPS12_062

- \bar{D} Slope distance as arithmetic mean of all measurements
- Σ Sum
- D_i Single slope distance measurement
- n Number of measurements
- s Standard deviation of a single slope distance measurement
- Σ Sum
- \bar{D} Slope distance as arithmetic mean of all measurements
- D_i Single slope distance measurement
- n Number of distance measurements

The standard deviation $S_{\bar{D}}$ of the arithmetic mean of the distance can be calculated as follows:

$$S_{\bar{D}} = \frac{s}{\sqrt{n}}$$

TPS12_063

$S_{\bar{D}}$	Standard deviation of the arithmetic mean of the distance
s	Standard deviation of a single measurement
n	Number of measurements

Index

A

- | | | | |
|--|-----|---|-----|
| Abbreviations | 12 | Of circular level on tribrach | 105 |
| Acclimatise to the ambient temperature | 92 | Of laser plummet | 112 |
| Accuracy | | Of Reflectorless EDM | 107 |
| Angle measurement | 168 | Preparation | 92 |
| Automatic Target Recognition ATR | 178 | Tilting axis (a) | 99 |
| IR mode | 170 | Adjustment Errors | |
| LO mode | 176 | View current | 89 |
| RL mode | 173 | Angle Measurement | 168 |
| SmartStation | 181 | Antenna | |
| Adjustment | | Communication side cover | 188 |
| Adjusting the direction of the beam | 110 | GFU19 clip-on-housing with device | 191 |
| Combined (l, t, i, c and ATR) | 94 | RadioHandle | 194 |
| Electronic | 88 | SmartAntenna | 196 |
| Inspecting the direction of the beam | 108 | Antennas | |
| Inspecting the laser plummet | 113 | Type | 184 |
| Mechanical | 89 | | |
| Of circular level on instrument | 104 | | |

Autodetect behaviour	53	C	
RadioHandle	54	CE	33
Radios/Modems	53	Check & Adjust	88
SmartAntenna	53	Cleaning and Drying	121
SmartAntenna Adapter	53	Clip-On-Housing	
Automatic Corrections	203	Attach and detach	62
Automatic Target Recognition ATR		Devices for	61
Accuracy	178	Insert SIM card	62
Description	147	LED indicators	65
Positioning of crosshairs	92	Remove SIM card	64
B		Communication side cover	
Battery		Graphical overview with RadioHandle	31
For instrument	75	Graphical overview with SmartStation	30
For SmartAntenna	77	Technical data	188
Icon	48	CompactFlash Card	21, 79
Internal, SmartAntenna	185	Format card	80
Overview	73	Icon	48
Technical data GEB171	201	Insert card	79
Technical data GEB221	201	Remove card	79
Bluetooth, icon	47	Safety instructions	79
		Compensator	197

Connector		Distance Measurement	
SmartAntenna	184	IR mode	169
Container Contents		LO mode	175
For instrument	24, 25	RL mode	172
For SmartStation and RCS	26, 27	Documentation	6
Control unit	198	Drive	
Conversion, data conversion	22	OMNI	22
Corrections		Drives	200
Automatic	203	E	
Scale	204	Edit	
D		Value in input field	40
Data Conversion	21	Electrical data, SmartAntenna	185
Data Storage	21	Electromagnetic Compatibility EMC	157
Dimensions		Electronic Adjustment	88
Of instrument	199	Electronic Distance Measurement EDM	
Of SmartStation	183	Description	13
SmartAntenna	184	PinPoint R100, PinPoint R300	14
		Screen icons	44, 45

Electronic Guide Light EGL		G	
Description	14, 151	GAT 3, antenna	190
Technical data	203	GeoC++ Software Development Kit	20
ENTER	34	GFU19	191
Environmental Specifications	201	GFU24	189
Environmental specifications		GFU25	191
SmartAntenna	186	GNSS = Global Navigation Satellite System	13
ESC	33	Guidelines for Correct Results	85
F		H	
FCC Statement	160	Hazards of Use	131
Flashing LED on clip-on-housing	67	I	
Formulas, reduction	211	Icons	
Frequency Band		Overview	44
Communication side cover	188	Specific for GPS	46
GFU19 clip-on-housing with device	191	Specific for TPS	45
RadioHandle	193		
SmartAntenna	195		
Frequency band			
GFU24, Siemens MC75	189		

Instrument		K	
Dimensions	199	Keyboard	32, 38
Ports	198	Locking and unlocking	38
Technical data	197	Operating principles	38
Turn on and turn off	38	Keys	33
Weight	199	Keys, Alphanumeric	33
Instrument Components	28	Keys, Arrow	34
Instrument Models	16	Keys, Combinations	34
Instrument Setup		Keys, Function	34
As SmartStation	55	Keys, Hot	33
Conventional	50	L	
For remote control	69	Laser Classification	137
Intended Use	125	Automatic Target Recognition ATR	147
Internal Memory	21	Electronic Guide Light EGL	151
Internal memory, icon	48	Integrated Distancer, Invisible Laser	137
		Integrated Distancer, Visible Laser	140
		Laser Plummet	153
		PowerSearch PS	149

Laser Plummet		Mount, SmartAntenna	184
Adjustment	112	MultiTech MTMMC-C	
Technical data	200	GFU19/GFU25, technical data	191
LED Indicators		O	
For clip-on-housing	65	OMNI drive	22
For RadioHandle	71	ON	33
For SmartAntenna	59	Operating Temperature	
LEICA Geo Office LGO, description	13, 17	SmartAntenna	186
Level	34, 197	Output Power	
Lights	34	Communication side cover	188
Li-Ion battery	185	GFU19 clip-on-housing with device	191
Lock, keyboard	38	RadioHandle	193
M		SmartAntenna	196
Maintenance	122	Output power	
Manual		GFU24, Siemens MC75	189
Validity of user manual	4		
Mechanical Adjustment	89		
Menu, selecting from a	39		

P		R	
Page		R100	14
Selecting from a	39	R300	14
Pages down	35	RadioHandle	
Pages up	35	Description	16
Ports	198	LED indicators	71
Power		Setup for remote control	69
SmartAntenna	185	Technical data	193
Power Supply	23	Raw data transfer to LGO	22
PowerSearch PS	180	Recording	200
Precise Measurements	89	Reduction Formulas	211
PROG	33	Reflectorless EDM, adjustment	107
Q		Reflectors	202
Quick coding, icon	48	Responsibilities	128
Quick settings	34		

S

Safety Directions	124
Scale Correction	204
Screen	36
Scroll bar, description	37
Service, of tripod	116
Setup	
As SmartStation	55
Conventional	50
For remote control	69
SHIFT	34, 48
Siemens MC75	
GFU24, technical data	189
SmartAntenna	
Battery	77
Description	16
Dimensions	183
Power supply	23
Status	59
Technical data	195

SmartStation

Communication side cover	16
Components	15
Container contents	26, 27
Description	15
Graphical overview	30
Setup	55
SmartAntenna	16
Technical Data	
Accuracy	181
Communication side cover	188
Dimensions	183
SmartAntenna	195

Software

Application programs	20
Customised application programs	20
Language software	19
Software type	19
Software upload	20
System software	19
Software Concept	19

Specifications, environmental		Temperature	
SmartAntenna	186	Battery Internal	
Status		Operating	201
Device in clip-on-housing	65	Storage	201
RadioHandle	71	Bluetooth	
SmartAntenna	59	Operating	201
Storage	120	Storage	201
Storage Temperature		CompactFlash Card	
SmartAntenna	186	Operating	201
Survey Application	82	Storage	201
System Concept	19	Instrument	
T		Operating	201
Technical Data	168	Storage	201
Telescope	197	Terminology	12
		Touch Screen, operating principles	38
		Transfer raw data to LGO	22
		Transport	118
		Tripod, service of	116

U

Unlock, keyboard	38
USER	33
User Interface	32

V

Value	
Edit in input field	40
View Current Adjustment Errors	89

W

Weight	
Of instrument	199
SmartAntenna	184

Total Quality Management: Our commitment to total customer satisfaction.



Leica Geosystems AG, Heerbrugg, Switzerland, has been certified as being equipped with a quality system which meets the International Standards of Quality Management and Quality Systems (ISO standard 9001) and Environmental Management Systems (ISO standard 14001).

Ask your local Leica Geosystems dealer for more information about our TQM program.

Leica Geosystems AG

Heinrich-Wild-Strasse
CH-9435 Heerbrugg
Switzerland
Phone +41 71 727 31 31

www.leica-geosystems.com

- when it has to be **right**

Leica
Geosystems